



2024 Golf Products Catalog



TOTAL SYSTEM SOLUTIONS

Everything You Need for Advanced Control of Your Irrigation.

As the only manufacturer committed exclusively to irrigation, Rain Bird designs fully integrated end-to-end solutions to address both new installation and system renovation challenges. This gives you total integration of components and a full system that is easier to manage and runs more efficiently than mix-and-match systems. Plus, you get a single source for service and other benefits available only from Rain Bird.

■ Central Control Technologies..... 4	■ Pump Stations & Filtration 42
■ Golf Rotors 10	■ Valves and Valve Boxes..... 52
■ IC System™ 24	■ Landscape Solutions..... 60
■ Field Control..... 30	■ Appendix 94
■ Integrated Course Control 38	

Distributed by:



www.centaur-asiapacific.com
info@centaur-asiapacific.com

*Singapore for Golf courses only.

Cover and Inside Cover Images:
Lake Nona Golf & Country Club

Rain Bird Golf products are designed specifically for large-scale irrigation installations such as golf courses. If your irrigation needs are smaller, please contact us for the right solution.

The TRUE Benefits™ of a Rain Bird System

Timeless Compatibility™

Every Rain Bird golf irrigation product is engineered for Timeless Compatibility, allowing you to have a state-of-the-art system that can be updated or changed without your existing equipment becoming obsolete.

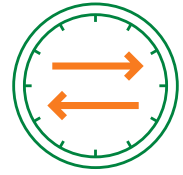

Real-Time Response

Rain Bird offers constant field monitoring with real-time communication, allowing the system to optimize for maximum efficiency and control. Whether adjusting to unpredictable weather conditions, unexpected course challenges or catastrophic issues, real-time response keeps you operating at peak levels.



Unmatched Quality

Through advanced engineering, design and testing, Rain Bird delivers on its mission to provide industry-leading quality to our customers. Our stringent testing procedures are implemented at the first launch of every product as well as regularly throughout the year, and they replicate the world's harshest conditions.



Easy To Use

All Rain Bird products are engineered with the challenges of golf professionals in mind and designed to deliver everyday ease of use. From software interfaces to rotor designs, they help you and your crew find a quicker, hassle-free path to top playability.





Whispering Pines

Central Control Technologies

Make Your Investment Work Smarter.

Level up your game with the CirrusPRO™ Central Control System. With real-time responses to changing conditions, you'll simplify irrigation management. Timeless Compatibility™ lets you rest assured that any Rain Bird software and its future updates will work with your existing field hardware.

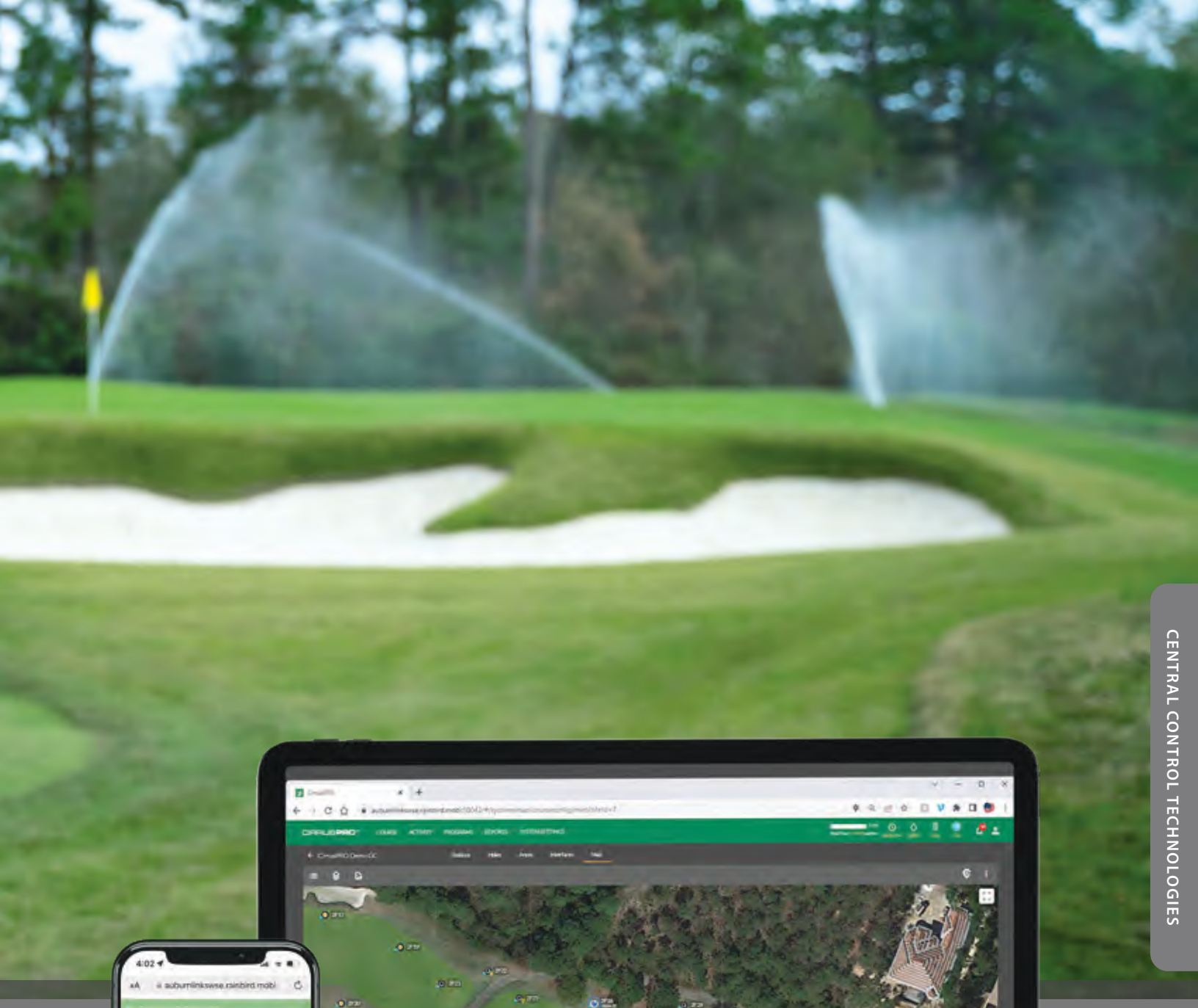

CENTRAL CONTROL TECHNOLOGIES

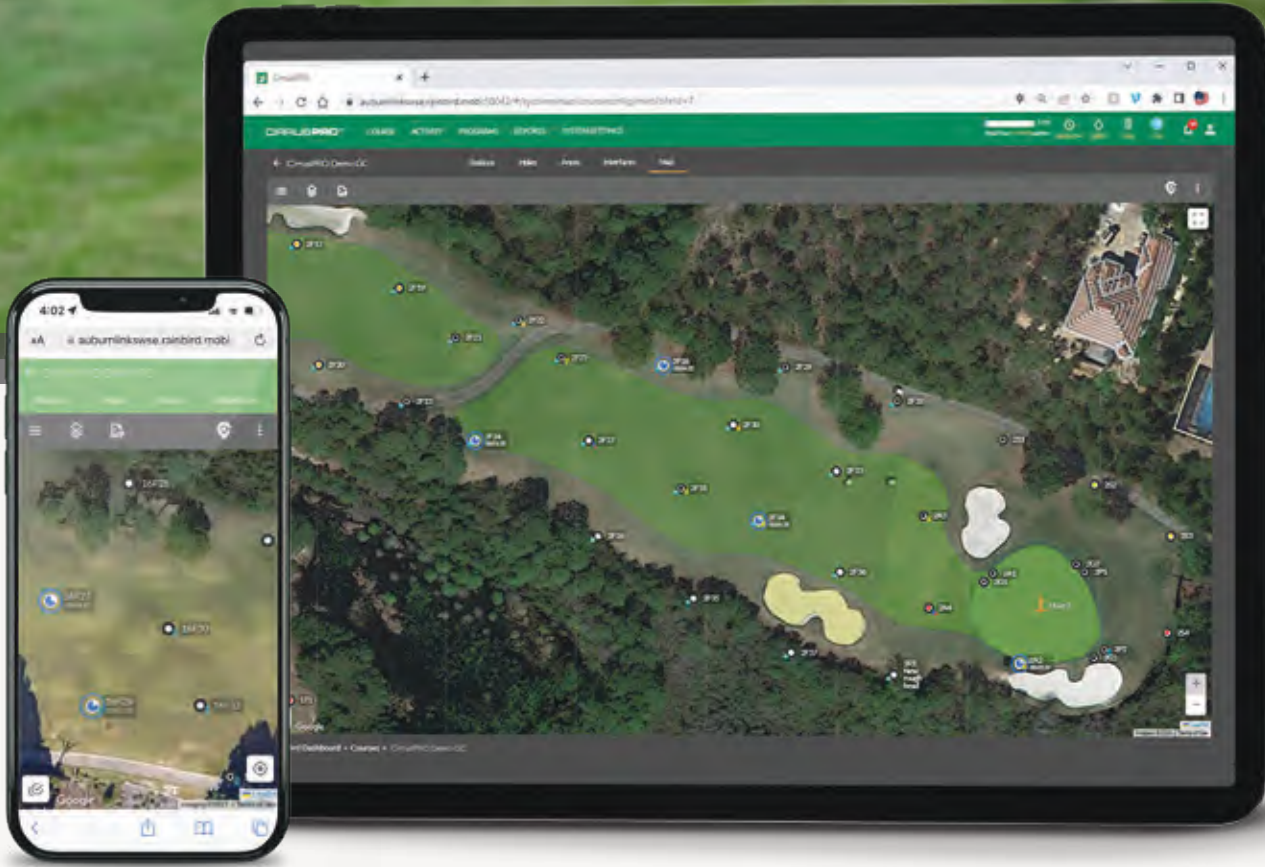



CirrusPRO™

Go completely mobile with CirrusPRO and get full central control from a mobile device anytime, anywhere, any place. With CirrusPRO you can make any irrigation changes directly from the map and watch your updates happen in real time. No matter what the day brings, you'll be ready with CirrusPRO.

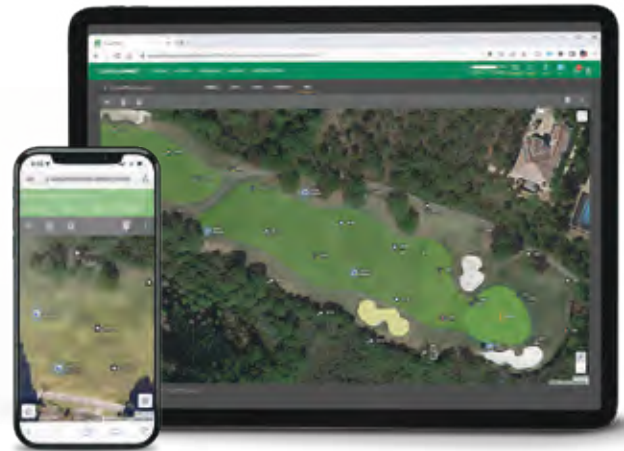

FEATURES & BENEFITS

Engineered to help you save time and money, CirrusPRO offers a state-of-the-art golf irrigation control system with an intuitive user interface (UI) and precise water management features.

- **Irrigation That Goes Where You Go:** As the only mobile-first irrigation control system on the market, you get a high level of performance from anywhere, on any device.
- **More Freedom:** Add unlimited users, choose from multiple languages and adjust settings for multiple stations all at once.

- **Better Data:** Irrigate precisely with real-time data that monitors and notifies about course conditions.
- **Complete Control:** Water through patented Rotation, Application, ET and Runtime.





SOFTWARE HIGHLIGHTS

- Custom course, hole and station names
- Programming in seconds, minutes and hours
- Runtime control through System Level Water Budget, Program Adjust, Schedule Adjust, Schedule Level Temporary Adjust, Program Level Temporary Adjust, Station Level Temporary Adjust as well as Station Adjust
- Detailed reports including: Station Runtime, Alarms and Warnings, Monthly Report Card, Monthly Flow, Flow Log Graph, Water Management, Yearly Water Consumption and Rainfall
- Weather data communication
- Automated email and texts for alarms
- Automatic weather-based adjustment from a wide range of weather source options
- User-selectable languages
- Configurable settings by user
- Make irrigation adjustments directly from the map
- Compatible with Rain Bird Golf Irrigation Systems

CUSTOM MAP LAYER ICONS

Check high-level information without selecting a station.

-  Identify stations with irrigation adjustments
-  View stations programmed for Cycle+Soak™
-  See remaining station time

STATION WINDOW

Map access offers important station information quickly and easily. Select any rotor on your map to access the station window. Then execute irrigation actions like starting, stopping, pausing and resuming a station. Users will see the time remaining, last time a station was irrigated, any active station adjustments, run and view diagnostics.

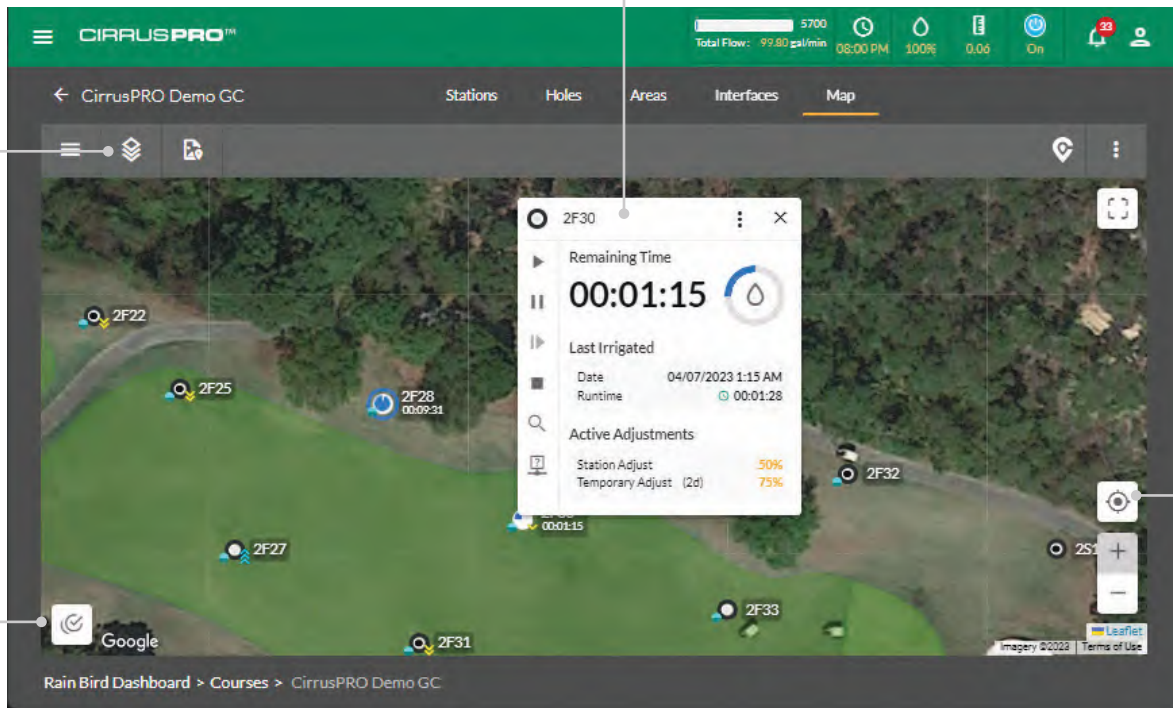

MULTI-STATION SELECTION

Complete tasks faster in fewer clicks. Select multiple stations while on the course to perform irrigation actions with ease.

FIND ME

Pinpoint current location to irrigate nearby areas with ease.

TROUBLESHOOT DIRECTLY FROM THE MAP

Eliminate the need for separate applications like MI or Freedom and quickly run irrigation or diagnostics in real time directly from the map.

IRRIGATE WITH PRECISE CONTROL

Patented watering by rotations gives you control of irrigation with unparalleled precision.

CUSTOM DASHBOARDS

Customize your dashboard with drag-and-drop functionality to display the data that matters to you.

OPTIMIZE YOUR IRRIGATION WITH DRYRUN™

Quickly preview the efficiency of your irrigation schedule allowing for adjustments prior to irrigation events to shorten water windows, optimize pump efficiency and save electricity.

Rain Can

A rain can working in tandem with our patented Rain Bird® Rain Watch™ technology responds in real time to rain events; reducing wear and tear and creating a more efficient, intelligent system.



FEATURES AND BENEFITS

- The only system designed to automatically react to rainfall and adjust sprinkler application rates to take full advantage of natural rain, thereby eliminating over-watering.
- Saves water and electricity, while keeping the course drier and more playable, by pausing, adjusting or canceling irrigation in the event of rainfall.
- Results in reduced wear and tear on irrigation system components.

HOW RAIN WATCH MANAGES RAINFALL

- Stationed throughout the course, up to four (4) high-resolution Rain Watch rain cans collect rainfall data.
- Each irrigation program can be set to react to any one of the available rain cans.
- The central control system continuously polls each rain can.
- Rainfall data received by the system is used to make intelligent decisions based on user-defined responses.

Weather Station

Enhance your turf's quality with Spectrum's WatchDog* weather station. By harnessing real-time evapotranspiration (ET) data, you can precisely irrigate using CirrusPRO for optimal results.

FEATURES AND BENEFITS

Efficient Water Management.

- CirrusPRO uses weather sensor input to determine ET rates based upon a field-proven proprietary equation for ET.
- Updated weather data can be viewed in CirrusPRO and used to calculate ET to determine irrigation times for the entire system or by specific areas or stations.
- Generate reports in CirrusPRO to show current or past weather conditions by the hour, day, week, month or year.

Easy to Use and Expand.

- CirrusPRO makes it easy to add multiple weather stations and connect them with specific areas of the golf course to provide precision control.
- WatchDog weather stations with CirrusPRO are simple to set up, configure and integrate.
- WatchDog offers five additional ports for increasing sensor inputs.

** Must be purchased through Rain Bird Authorized Distributor*



The FREEDOM System™

The FREEDOM System handheld provides reliable, two-way communication with your Rain Bird system. Use it to choose from command-based or schedule-based operations, making irrigation adjustments a snap. Either way, The FREEDOM System puts you in control of your irrigation management system wherever you are.

SYSTEM FEATURES AND BENEFITS

- **Two-way Communication with Rain Bird Centrals.** Audio response at radio indicates command received by central.
- **Station- and Program-Based Commands.** Provides the flexibility to turn ON or OFF any station or an entire area with the click of a few buttons.
- **FREEDOM-Based Commands Recorded at Central.** Irrigation activity logged at the central whether stations turned ON with FREEDOM System or with central.
- **Optional Flo-Manager® Bypass.** Permits FREEDOM user to bypass Flo-Manager.
- **Optional Operating Window.** Allows user to define FREEDOM usage hours, which helps superintendents to control irrigation activity.
- **Two-Way Voice Communication.**
- **Telephone Operation.** All FREEDOM commands can be activated using a telephone connection.

RADIO FEATURES AND BENEFITS

Weather-resistant and reliable. The NX-3320-k3 handheld radio is built to survive the drops, hard-knocks and weather environments of its users. The NX-3320-k3 meets or exceeds the demanding MIL-STD "driven rain" standard, which guarantees water-resistant performance even in wet weather.

- **LCD Display.** 4-line basic (2-line main/sub-LCD, icon & key guide) with 14 characters; 5-line text message frame (3 lines of text, icon & key guide).
- **Extra-Long Battery Life.** 1400 mAh batteries deliver more than nine (9) hours of operating time on a single charge (5-5-90 duty).
- **One-Year Warranty.**
- **MIL-STD 810 C/D/E/F Environmental Tests.** Meets or exceeds the stringent IP/54/55 dust and IP67 water intrusion standards and full range of tough MIL-STD 810 C, D, E, F and G environmental standards in categories such as vibration, shock, dust, humidity, rain, temperature, solar radiation and atmospheric pressure.

SPECIFICATIONS

Frequency: 450 – 470 MHz (Narrowband)

NOTE: Site survey and license required

Power:
100 V/110 V: 60 Hz

HOW TO SPECIFY

FREEDOM	–	SP
MODEL		CONTROL TYPE
FREEDOM		SP





Chiricahua at Desert Mountain

Golf Rotors

Peace of Mind Today. Continuous Innovation for the Future.

Rain Bird builds innovation into every rotor with high-efficiency nozzles, industry-leading surge resistance and the largest throw range in a single rotor. Trusted by golf professionals everywhere, Rain Bird rotors deliver unrivaled performance and uniformity for excellent playability.

Unmatched GBS25 Protection

Delivering 25kV surge protection and built-in filtration for debris, the GBS25 Solenoid eliminates the most common maintenance tasks that plague competing rotors.

Top Serviceability

With superior performance in a smaller footprint than competing rotors and an intelligent snap-ring design for quick access to serviceable components, Rain Bird rotors have long been the perfect choice for golf courses.

Consistent Uniform Application

The self-adjusting stator automatically modifies flow to control rotation speed, optimizing performance and providing a consistent water application.



NEW

952 Series: 70' to 101' (21.3 m to 30.8 m)

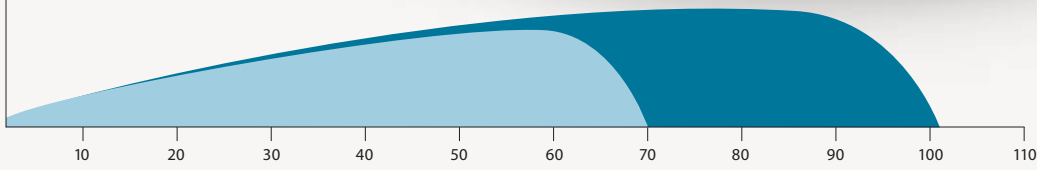

702 Series: 59' to 77' (18.0 m to 23.5 m)
752 Series: 30' to 84' (9.1 m to 25.6 m)

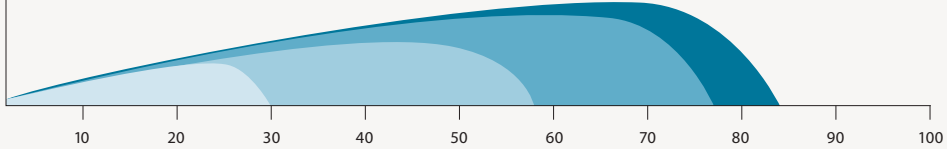

552 Block Rotors: 33' to 55' (10.1 m to 16.8 m)

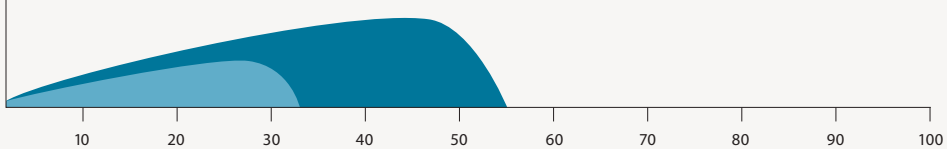

952 Series Rotors



SPECIFICATIONS

Radius: 70' to 101' (21.3 m to 31.8 m)
Flow Rate: 19.7 to 54.5 gpm (1.24 to 3.44 l/s)
 (4.43 to 12.38 m³/h)
Arc: Full-circle 360°; Adjustable 30° to 345°
Models:
 E: Electric
 IC: Integrated Control
 SAM: Stopamatic
Maximum Inlet Pressure:
 Models E and IC: 150 psi (10.3 bar)
 Model SAM: 100 psi (6.9 bar)
Pressure Regulation Range:
 Models E and IC: 60 to 100 psi
 (4.1 to 6.9 bar)
Factory Pressure Settings: Models E and IC
 available in 70 and 80 psi (4.8 and 5.5 bar)

Dimensions:
Body Height: 13.4" (34.0 cm)
Pop-Up Height to Mid-Nozzle:
 2.6" (6.6 cm)
Top Diameter: 7.0" (17.8 cm)
Nozzle Trajectory:
Standard: 25°; **Low Angle:** 17°
Inlet Threads: 1.5" (38.0 mm)
 ACME female threaded
Holdback:
SAM: 17' (5.2 m) elevation
Rotation Time: 180° in ≤ 100 seconds;
 80 seconds nominally
Maximum Stream Height:
Standard: 22' (6.7 m)
Low Angle: 12' (3.7 m)
Solenoid: 24 VAC solenoid power requirement:
 0.41 amp inrush current (9.8 VA);
60 Hz: 0.25 amp holding current (6.0 VA);
50 Hz: 0.32 amp holding current (7.7 VA)

Surge Resistance: 25kV standard
 on electric models and 20kV on IC models
**Top-Serviceable Rock Screen™ and
 Replaceable Valve Seat:** All models
Special Features:
 Self-Adjusting Stator; Rear Nozzle Plug

U.S. Performance Data

FRONT NOZZLES															
	Base Pressure (psi)	#44 – Blue		#46 – Tan		#48 – Yellow		#52 – Orange		#56 – Green		#60 – Black		#64 – Red	
		Radius (ft)	Flow (gpm)	Radius (ft)	Flow (gpm)	Radius (ft)	Flow (gpm)	Radius (ft)	Flow (gpm)	Radius (ft)	Flow (gpm)	Radius (ft)	Flow (gpm)	Radius (ft)	Flow (gpm)
STANDARD	60	70	19.7	74	22.9	76	27.1	79	31.5	81	35.3	83	38.8	85	42
	70	71	21.3	74	25.0	78	29.7	81	34	84	38.2	86	42.1	89	47.1
	80	73	22.8	76	26.7	79	31.6	83	36.3	87	41	88	44.9	93	48.7
	90	73	23.8	78	28.5	82	33.3	85	38.4	90	42.8	91	47.6	98	51.7
	100	74	25	78	30.2	82	35.1	88	40.6	92	45.5	94	49.1	101	54.5
LOW-ANGLE	60	70	19.7	75	23.2	77	27.7	78	31.8	82	35.9	81	39.4	—	—
	70	74	21.1	77	25.2	80	30	83	34.2	87	38.7	86	42.6	—	—
	80	76	22.9	78	26.6	82	31.5	86	36.6	89	40.9	89	45.6	—	—
	90	77	24.1	80	28.7	84	33.5	87	38.7	90	43.4	92	48.1	—	—
	100	79	25.4	80	30.2	86	35.4	89	40.8	94	46	96	51	—	—

Metric Performance Data

FRONT NOZZLES																						
	Base Pressure (bar)	#44 – Blue		#46 – Tan		#48 – Yellow		#52 – Orange		#56 – Green		#60 – Black		#64 – Red								
		Radius (m)	Flow (m ³ /h)	Flow (l/s)	Radius (m)	Flow (m ³ /h)	Flow (l/s)	Radius (m)	Flow (m ³ /h)	Flow (l/s)	Radius (m)	Flow (m ³ /h)	Flow (l/s)	Radius (m)	Flow (m ³ /h)	Flow (l/s)						
STANDARD	4.1	21.3	4.5	1.24	22.5	5.2	1.45	23.2	6.2	1.71	24.1	7.2	1.99	24.7	8.0	2.23	25.3	8.8	2.45	25.9	9.5	2.65
	4.8	21.6	4.8	1.34	22.7	5.7	1.58	23.8	6.7	1.87	24.7	7.7	2.15	25.6	8.7	2.41	26.2	9.6	2.66	27.1	10.7	2.97
	5.5	22.3	5.2	1.44	23.1	6.1	1.68	24.1	7.2	1.99	25.3	8.2	2.29	26.5	9.3	2.59	26.8	10.2	2.83	28.3	11.1	3.07
	6.2	22.3	5.4	1.50	23.7	6.5	1.80	25.0	7.6	2.10	25.9	8.7	2.42	27.4	9.7	2.70	27.7	10.8	3.00	29.9	11.7	3.26
	6.9	22.6	5.7	1.58	23.7	6.9	1.91	25.0	8.0	2.21	26.8	9.2	2.56	28.0	10.3	2.87	28.7	11.2	3.10	30.8	12.4	3.44
LOW-ANGLE	4.1	21.3	4.5	1.24	22.9	5.3	1.47	23.5	6.3	1.75	23.8	7.2	2.01	25.0	8.2	2.26	24.7	8.9	2.49	—	—	—
	4.8	22.6	4.8	1.33	23.5	5.7	1.59	24.4	6.8	1.89	25.3	7.8	2.16	26.5	8.8	2.44	26.2	9.7	2.69	—	—	—
	5.5	23.2	5.2	1.44	23.9	6.0	1.68	25.0	7.2	1.99	26.2	8.3	2.31	27.1	9.3	2.58	27.1	10.4	2.88	—	—	—
	6.2	23.5	5.5	1.52	24.3	6.5	1.81	25.6	7.6	2.11	26.5	8.8	2.44	27.4	9.9	2.74	28.0	10.9	3.03	—	—	—
	6.9	24.1	5.8	1.60	24.5	6.9	1.91	26.2	8.0	2.23	27.1	9.3	2.57	28.7	10.4	2.90	29.3	11.6	3.22	—	—	—

HOW TO SPECIFY

A	-	952	-	X	-	XX	-	XX
THREAD TYPE ACME	MODEL 952	BODY/VALVE E IC SAM	PRESSURE REGULATOR 70 (4.8) 80 (5.5)	NOZZLE 44 46 48 52 56 60 64				

Turn-of-a-Screw Adjustments

The same time-saving Rapid-Adjust Technology as the 752, now available on the 952.

(See page 14 for details)



REAR-SPREADER NOZZLES – U.S. PERFORMANCE DATA

Spreader Nozzle Color	Flow (gpm)	Nozzle Range		Flow (gpm)	Nozzle Range		Flow (gpm)	Nozzle Range		Flow (gpm)	Nozzle Range		Flow (gpm)	Nozzle Range		Flow (gpm)	Nozzle Range		Flow (gpm)	Nozzle Range				
		Main (ft)	Rear (ft)		Main (ft)	Rear (ft)		Main (ft)	Rear (ft)		Main (ft)	Rear (ft)		Main (ft)	Rear (ft)		Main (ft)	Rear (ft)		Main (ft)	Rear (ft)	Main (ft)	Rear (ft)	
MAIN NOZZLE #44 – BLUE																								
Pressure (psi)	70		80		70		80		70		80		70		80		70		80					
Orange	23.9	69	35	25.4	71	35	28.4	71	33	29.2	73	33	32.1	75	33	34.1	77	33	36.5	80	33	39.0	83	32
Green	27.7	69	52	29.6	70	51	31.0	73	51	32.8	73	49	35.7	75	50	37.8	77	50	39.9	79	50	42.3	81	50
Blue	26.5	69	41	28.2	70	41	30.5	71	45	33.6	73	43	34.4	76	40	37.0	77	39	39.6	81	39	41.9	83	39
Black	28.6	68	43	28.9	71	43	30.9	71	43	32.1	73	45	35.1	75	41	37.5	77	41	39.7	79	40	43.9	80	40
Red	25.9	68	52	27.4	69	51	29.9	71	33	31.6	73	31	34.2	74	51	36.4	77	52	38.4	79	50	40.8	80	51
Blue + Diffuser	24.4	70	35	26.0	70	34	28.2	73	35	29.9	75	35	32.5	75	35	34.7	77	34	37.1	81	35	39.1	83	33
Black + Diffuser	24.2	69	35	25.9	71	33	28.2	73	35	30.0	71	35	33.3	76	34	34.7	78	34	36.9	79	33	39.5	81	33
MAIN NOZZLE #56 – GREEN																								
Pressure (psi)	70		80		70		80		70		80		70		80									
Orange	40.6	83	33	43.8	86	33	44.3	85	32	47.4	87	31	48.2	89	33	51.4	92	33						
Green	44.0	80	50	46.8	84	50	47.9	83	49	50.7	85	49	51.8	85	49	53.3	89	50						
Blue	43.7	83	39	46.1	85	39	47.1	85	39	50.3	87	38	50.7	88	39	54.0	92	37						
Black	43.5	81	40	46.5	85	39	47.4	85	39	50.6	87	39	49.9	85	40.7	55	91	39						
Red	42.4	82	50	45.4	84	50	46.1	83	51	49.9	86	50	50.0	87	50	53.1	89	51						
Blue + Diffuser	41.3	82	34	44.2	85	33	45.3	83	33	48.2	85	33	48.5	86	33	52.7	90	35						
Black + Diffuser	41.5	83	34	44.6	86	33	45.3	84	32	48.3	87	32	48.6	87	31	51.7	87	31						
MAIN NOZZLE #60 – BLACK																								
MAIN NOZZLE #64 – RED																								

REAR-SPREADER NOZZLES – METRIC PERFORMANCE DATA

Spreader Nozzle Color	Flow (m³/h)	Flow (l/s)	Nozzle Range		Flow (m³/h)	Flow (l/s)	Nozzle Range		Flow (m³/h)	Flow (l/s)	Nozzle Range		Flow (m³/h)	Flow (l/s)	Nozzle Range		Flow (m³/h)	Flow (l/s)	Nozzle Range		Flow (m³/h)	Flow (l/s)										
			Main (m)	Rear (m)			Main (m)	Rear (m)			Main (m)	Rear (m)			Main (m)	Rear (m)			Main (m)	Rear (m)			Main (m)	Rear (m)								
MAIN NOZZLE #44 – BLUE																																
Pressure (bar)	4.8		5.5		4.8		5.5		4.8		5.5		4.8		5.5		4.8		5.5													
Orange	5.4	1.51	21.1	10.6	5.8	1.60	21.7	10.8	6.3	1.79	21.6	10.1	6.6	1.84	22.3	10.1	7.3	2.02	23.0	10.2	7.7	2.15	23.6	10.2	8.3	2.30	24.4	10.0	8.9	2.46	25.4	9.8
Green	6.3	1.75	20.9	15.8	6.7	1.87	21.3	15.6	6.9	1.96	22.3	15.5	7.4	2.07	22.3	14.9	8.1	2.25	23.0	15.2	8.6	2.39	23.4	15.2	9.1	2.52	24.2	15.2	9.6	2.67	24.8	15.2
Blue	6.0	1.67	21.1	12.6	6.4	1.78	21.3	12.6	6.8	1.92	21.6	13.7	7.6	2.12	22.3	13.1	7.8	2.17	23.2	12.2	8.4	2.34	23.6	12.0	9.0	2.50	24.6	12.0	9.5	2.64	25.2	11.8
Black	6.5	1.81	20.7	13.0	6.6	1.82	21.5	13.2	6.9	1.95	21.6	13.1	7.3	2.03	22.3	13.7	8.0	2.22	23.0	12.4	8.5	2.37	23.6	12.4	9.0	2.51	24.0	12.2	10.0	2.77	24.4	12.2
Red	5.9	1.63	20.7	15.8	6.2	1.73	20.9	15.6	6.7	1.89	21.6	10.1	7.2	1.99	22.3	9.4	7.8	2.15	22.6	15.6	8.3	2.30	23.4	15.8	8.7	2.42	24.0	15.2	9.3	2.57	24.4	15.4
Blue + Diffuser	5.5	1.54	21.3	10.8	5.9	1.64	21.3	10.4	6.3	1.78	22.3	10.7	6.8	1.89	22.9	10.7	7.4	2.05	23.0	10.6	7.9	2.19	23.6	10.4	8.4	2.34	24.6	10.6	8.9	2.47	25.2	10.2
Black + Diffuser	5.5	1.52	21.1	10.6	5.9	1.64	21.7	10.2	6.3	1.78	22.3	10.7	6.8	1.89	21.6	10.7	7.6	2.10	23.2	10.4	7.9	2.19	23.8	10.4	8.4	2.33	24.0	10.0	9.0	2.49	24.8	10.0
MAIN NOZZLE #56 – GREEN																																
MAIN NOZZLE #60 – BLACK																																
MAIN NOZZLE #64 – RED																																
Pressure (bar)	4.8		5.5		4.8		5.5		4.8		5.5		4.8		5.5																	
Orange	9.2	2.56	25.4	10.2	9.9	2.76	26.2	10.2	10.1	2.80	25.8	9.8	10.8	2.99	26.6	9.6	10.9	3.04	27.0	10.0	11.7	3.24	28.0	10.2								
Green	10.0	2.77	24.4	15.2	10.6	2.95	25.6	15.2	10.9	3.02	25.2	14.8	11.5	3.20	26.0	15.0	11.8	3.26	26.0	15.0	12.1	3.36	27.2	15.2								
Blue	9.9	2.75	25.4	12.0	10.5	2.91	26.0	11.8	10.7	2.97	25.8	11.8	11.4	3.18	26.6	11.6	11.5	3.20	26.8	11.8	12.3	3.40	28.0	11.4								
Black	9.9	2.74	24.8	12.2	10.6	2.93	25.8	12.0	10.8	2.99	25.8	11.8	11.5	3.19	26.4	12.0	11.3	3.15	26.0	12.4	12.4	3.44	27.6	11.8								
Red	9.6	2.68	25.0	15.2	10.3	2.86	25.6	15.2	10.5	2.91	25.4	15.4	11.3	3.15	26.2	15.2	11.4	3.15	26.4	15.2	12.1	3.35	27.0	15.4								
Blue + Diffuser	9.4	2.60	25.0	10.4	10.0	2.79	25.8	10.2	10.3	2.85	25.3	10.1	10.9	3.04	25.9	10.1	11.0	3.06	26.2	10.2	12.0	3.32	27.4	10.6								
Black + Diffuser	9.4	2.62	25.2	10.4	10.1	2.81	26.2	10.2	10.3	2.86	25.6	9.8	11.0	3.05	26.6	9.8	11.0	3.07	26.6	9.6	11.7	3.26	26.6	9.6								

752 Series Rotors

SPECIFICATIONS

Radius: 30' to 84' (9.1 m to 25.6 m)

Flow Rate: 6.8 to 47.0 gpm (0.43 to 2.97 l/s)
(1.54 to 10.68 m³/h)

Arc: Full-circle 360°; Adjustable 30° to 345°

Models:

- E:** Electric
- IC:** Integrated Control
- B:** Block with Seal-A-Matic™ device

Maximum Inlet Pressure:

- Models E and IC:** 150 psi (10.3 bar). For low-flow valve operation refer to chart in appendix on page 105
- Model B:** 100 psi (6.9 bar)

Pressure Regulation Range:

- Models E and IC:** 60 to 100 psi (4.1 to 6.9 bar)

Factory Pressure Settings: Models E and IC available in 70 and 80 psi (4.8 and 5.5 bar)

Dimensions:

- Body Height:**
- Models E, IC:** 12.0" (30.5 cm)
- Model B:** 9.6" (24.5 cm)

- Pop-Up Height to Mid-Nozzle:**
- Models E, IC, B:** 2.6" (6.6 cm)

- Top Diameter:**
- Models E, IC:** 6.25" (15.9 cm)
- Model B:** 4.25" (10.8 cm)

Nozzle Trajectory:

- Standard:** 25°
- Wind Tolerant:** 12°
- Low Angle:** 15°

Inlet Threads:

- Models E, IC:** 1.25" (32 mm) ACME female threaded
- Model B:** 1" (25 mm) ACME female threaded

Holdback:

- Block:** 17' (5.2 m) elevation

Rotation Time: 180° in ≤ 90 seconds; 80 seconds nominally

Maximum Stream Height:

- Standard:** 17' (5.2 m)
- Wind Tolerant:** 10' (3.1 m)
- Low Angle:** 12' (3.7 m)

Solenoid: 24 VAC solenoid power requirement: 0.41 amp inrush current (9.8 VA);

- 60 cycle:** 0.25 amp holding current (6.0 VA);
- 50 cycle:** 0.32 amp holding current (7.7 VA)

Surge Resistance: Up to 25kV standard on electric models and 20kV on IC models

Top-Serviceable Rock Screen™ and Replaceable Valve Seat: On models E, IC

Special Features:

- Self-Adjusting Stator**
- Optional Sod Cup**

Meet Challenging Field Conditions

The Rain Bird® 752 Series Rotor gives the user the capability to optimize rotors to meet challenging field conditions such as elevation differences and obstacles.

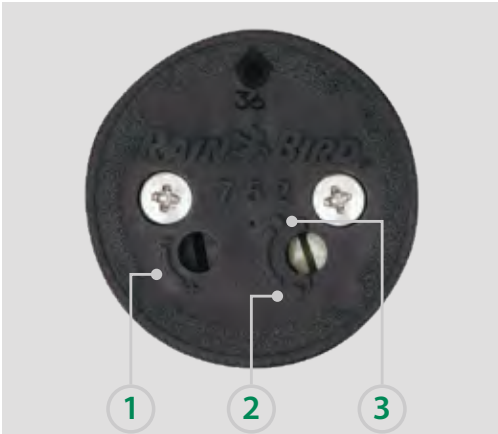

Turn-of-a-Screw Adjustments

Whether you're catering to grow-in or just trying to get more from a limited water supply, Rapid-Adjust Technology lets your staff make easy arc adjustments with the turn of a screw. MemoryArc® retains two part-circle arc settings, so you can shift between full- and part-circle operation in seconds.



Step 1

Set primary rotor arc.



Step 2

Turn the Full/Part Adjustment Screw for full-circle operation.



Step 3

Turn the rotor to either Arc A or Arc B setting, then set to part-circle. No need to reset the arc when changing between full- and part-circle settings.

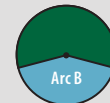

GOLF ROTORS



HOW TO SPECIFY

A	752	XX	XX	XX
THREAD TYPE	MODEL	BODY/ VALVE	PRESSURE REGULATOR	NOZZLE
ACME	752	E	70 (4.8)	18 32
		IC	80 (5.5)	20 36
		B		22 40
				24 44
				26 48
				28 50

U.S. Performance Data

DUAL-SPREADER™ NOZZLES WITH STANDARD AND LOW ANGLE (LA) HOUSINGS																		
Base Pressure (psi)	50			60			70			80			90			100		
	Radius (ft)	LA (ft)	Flow (gpm)	Radius (ft)	LA (ft)	Flow (gpm)	Radius (ft)	LA (ft)	Flow (gpm)	Radius (ft)	LA (ft)	Flow (gpm)	Radius (ft)	LA (ft)	Flow (gpm)	Radius (ft)	LA (ft)	Flow (gpm)
REQUIRES LOW-FLOW VALVE																		
#18 - Beige	—	—	—	—	—	—	30	—	6.8	31	—	7.2	32	—	7.5	34	—	7.8
#20 - Gray	—	—	—	—	—	—	37	34	8.4	38	35	9.1	39	36	9.5	40	37	10.0
#22 - Red	41	38	8.8	43	40	9.7	44	41	10.2	44	42	10.8	44	42	11.5	44	43	12.0
#24 - Plum	46	42	8.3	47	43	8.9	47	44	9.6	48	44	10.2	48	45	10.8	48	46	11.4
#26 - Lt. Green	50	46	9.5	50	45	10.1	51	47	10.9	51	49	11.6	52	49	12.3	53	50	12.8
REQUIRES STANDARD VALVE																		
#28 - White	54	51	14.9	56	54	16.4	58	56	17.6	58	57	18.8	57	58	20.2	59	57	21.4
#32 - Blue	62	54	17.1	62	56	19.0	63	59	20.3	63	61	21.8	67	61	22.9	67	61	24.0
#36 - Yellow	64	59	19.5	65	62	21.3	66	64	23.2	68	65	24.7	68	66	26.2	69	68	27.2
#40 - Orange	63	63	22.3	65	64	24.0	67	66	26.3	68	67	27.9	69	68	29.7	69	68	31.1
#44 - Green	—	—	—	67	66	26.9	69	68	28.6	71	70	30.6	71	71	32.5	73	71	34.0
#48 - Black	—	—	—	—	—	—	76	70	31.5	76	72	34.0	76	74	35.8	75	76	38.5
#50 - Dk. Brown	—	—	—	—	—	—	79	68	39.4	81	70	41.9	82	73	44.7	84	75	47.0

Metric Performance Data

DUAL-SPREADER™ NOZZLES WITH STANDARD AND LOW ANGLE (LA) HOUSINGS																								
Base Pressure (bar)	3.4				4.1				4.8				5.5				6.2				6.9			
	Radius (m)	LA (m)	Flow (m³/h)	Flow (l/s)	Radius (m)	LA (m)	Flow (m³/h)	Flow (l/s)	Radius (m)	LA (m)	Flow (m³/h)	Flow (l/s)	Radius (m)	LA (m)	Flow (m³/h)	Flow (l/s)	Radius (m)	LA (m)	Flow (m³/h)	Flow (l/s)				
REQUIRES LOW-FLOW VALVE																								
#18 - Beige	—	—	—	—	—	—	—	—	9.1	—	1.54	0.43	9.5	—	1.63	0.45	9.8	—	1.70	0.47	10.4	—	1.77	0.49
#20 - Gray	—	—	—	—	—	—	—	—	11.3	10.4	1.92	0.53	11.6	10.7	2.06	0.57	11.9	11.0	2.15	0.60	12.2	11.3	2.27	0.63
#22 - Red	12.5	11.6	2.00	0.56	13.1	12.2	2.19	0.61	13.4	12.5	2.32	0.64	13.4	12.8	2.45	0.68	13.4	12.8	2.60	0.72	13.4	13.1	2.73	0.76
#24 - Plum	14.0	12.8	1.89	0.53	14.3	13.1	2.02	0.56	14.3	13.4	2.18	0.61	14.6	13.4	2.31	0.64	14.6	13.7	2.45	0.68	14.6	14.0	2.59	0.72
#26 - Lt. Green	15.2	14.0	2.16	0.60	15.2	13.7	2.30	0.64	15.5	14.3	2.48	0.69	15.5	14.9	2.64	0.73	15.9	14.9	2.80	0.78	16.2	15.2	2.90	0.80
REQUIRES STANDARD VALVE																								
#28 - White	16.5	15.5	3.38	0.94	17.1	16.5	3.71	1.03	17.7	17.1	3.99	1.11	17.7	17.4	4.27	1.19	17.4	17.7	4.58	1.27	18.0	17.4	4.86	1.35
#32 - Blue	18.9	16.5	3.88	1.08	18.9	17.1	4.32	1.20	19.2	18.0	4.62	1.28	19.2	18.6	4.94	1.37	20.4	18.6	5.20	1.44	20.4	18.6	5.44	1.51
#36 - Yellow	19.5	18.0	4.44	1.23	19.8	18.9	4.84	1.35	20.1	19.5	5.27	1.47	20.7	19.8	5.61	1.56	20.7	20.1	5.96	1.65	21.0	20.7	6.18	1.72
#40 - Orange	19.2	19.2	5.06	1.40	19.8	19.5	5.44	1.51	20.4	20.1	5.98	1.66	20.7	20.4	6.34	1.76	21.0	20.7	6.75	1.87	21.0	20.7	7.06	1.96
#44 - Green	—	—	—	—	20.4	20.1	6.12	1.70	21.0	20.7	6.49	1.80	21.6	21.3	6.95	1.93	21.6	21.6	7.38	2.05	22.3	21.6	7.73	2.15
#48 - Black	—	—	—	—	—	—	—	—	23.2	21.3	7.15	1.99	23.2	22.0	7.71	2.14	23.2	22.6	8.13	2.26	22.9	22.9	8.74	2.43
#50 - Dk. Brown	—	—	—	—	—	—	—	—	24.1	20.7	8.94	2.48	24.7	21.3	9.52	2.64	25.0	22.3	10.16	2.82	25.6	22.9	10.68	2.97

Typical Installation:

Watering area behind the Rain Bird® 752.

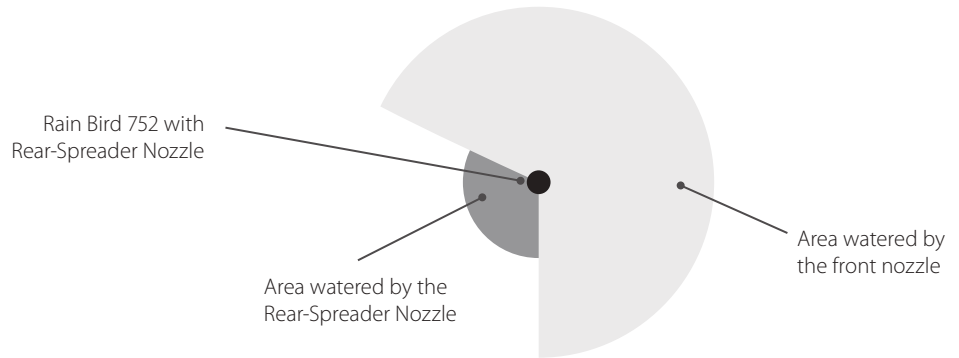

752 Series U.S. Performance Data

REAR-SPREADER NOZZLES																		
Spreader Nozzle Color	Flow (gpm)	Nozzle Range		Flow (gpm)	Nozzle Range		Flow (gpm)	Nozzle Range		Flow (gpm)	Nozzle Range		Flow (gpm)	Nozzle Range		Flow (gpm)	Nozzle Range	
		Main (ft)	Rear (ft)		Main (ft)	Rear (ft)		Main (ft)	Rear (ft)		Main (ft)	Rear (ft)		Main (ft)	Rear (ft)		Main (ft)	Rear (ft)
MAIN NOZZLE #18 – BEIGE						MAIN NOZZLE #20 – GRAY						MAIN NOZZLE #22 – RED						
Pressure (psi)	70			80			70			80			70			80		
Orange	11.3	26	36	12.2	28	36	11.4	38	36	12.2	38	34	13.0	42	32	13.6	42	34
Green	13.9	26	52	14.6	28	52	15.3	34	50	16.3	36	52	16.4	40	52	17.5	40	52
Blue	14.2	26	48	15.2	26	48	15.6	36	48	16.6	36	44	16.7	42	46	17.9	42	46
Black	13.3	26	46	14.0	26	46	14.5	36	46	15.3	36	46	15.8	40	44	16.9	42	44
Red	12.3	26	50	12.9	26	52	13.3	36	50	14.3	36	52	14.7	40	50	15.8	40	50
Blue + Diffuser	10.8	26	34	11.3	28	34	12.2	36	34	12.8	38	34	13.5	40	32	14.3	40	34
Black + Diffuser	11.4	27	32	11.1	28	32	12.1	36	33	12.8	37	32	13.2	39	32	14.1	39	32
MAIN NOZZLE #24 – PLUM						MAIN NOZZLE #26 – LT. GREEN						MAIN NOZZLE #28 – WHITE						
Pressure (psi)	70			80			70			80			70			80		
Orange	12.2	44	32	12.9	44	32	15.0	48	32	16.0	52	34	20.3	58	34	21.8	58	34
Green	15.9	44	50	16.9	46	50	18.7	48	50	19.9	50	52	23.8	56	50	25.0	56	50
Blue	16.2	44	46	17.3	44	46	18.9	50	46	20.2	50	46	24.3	56	42	25.8	56	42
Black	15.2	44	46	16.4	44	46	17.3	48	44	18.5	48	44	23.3	58	40	24.7	58	40
Red	14.1	46	50	15.2	46	50	16.8	48	50	17.8	48	52	22.4	60	50	23.6	58	50
Blue + Diffuser	13.0	46	34	13.8	44	34	15.2	50	34	16.3	50	34	21.4	60	34	22.6	60	34
Black + Diffuser	12.7	44	32	13.6	44	32	15.5	47	31	16.5	48	31	20.8	57	32	22.4	58	31
MAIN NOZZLE #32 – BLUE						MAIN NOZZLE #36 – YELLOW						MAIN NOZZLE #40 – ORANGE						
Pressure (psi)	70			80			70			80			70			80		
Orange	22.5	64	32	24.1	64	32	25.0	66	32	26.8	66	32	28.2	68	30	30.1	68	30
Green	25.8	60	50	27.5	62	50	28.4	64	48	31.8	64	48	31.6	68	46	33.2	68	46
Blue	25.8	60	42	27.5	60	42	28.5	64	40	30.5	64	40	31.5	66	40	33.5	66	40
Black	25.5	60	38	27.1	60	40	28.2	64	38	29.6	64	36	38.7	66	38	32.9	68	38
Red	24.1	62	48	25.9	62	48	27.0	64	48	29.0	66	48	30.1	68	48	32.3	68	48
Blue + Diffuser	23.3	62	32	24.7	62	34	26.1	64	34	27.9	68	34	38.2	68	32	38.5	68	32
Black + Diffuser	22.9	61	31	24.4	61	31	25.9	64	31	27.5	66	31	28.4	67	30	30.8	68	30
MAIN NOZZLE #44 – GREEN						MAIN NOZZLE #48 – BLACK						MAIN NOZZLE #50 – DK. BROWN						
Pressure (psi)	70			80			70			80			70			80		
Orange	30.6	68	32	32.7	70	30	33.4	70	30	35.9	70	30	41.1	74	30	43.7	76	30
Green	33.6	68	46	36.2	70	46	36.2	66	46	38.7	70	46	43.6	72	42	46.2	74	42
Blue	34.7	68	38	36.6	70	38	36.9	66	34	40.0	68	36	43.4	72	36	46.5	74	36
Black	33.3	68	38	34.9	70	38	35.9	68	38	38.1	70	38	42.7	72	34	45.8	74	34
Red	32.5	68	48	34.5	70	48	34.8	70	46	37.5	72	46	42.3	72	44	44.8	74	44
Blue + Diffuser	31.4	70	32	33.7	72	32	34.6	70	34	36.0	72	34	41.6	74	32	44.2	76	32
Black + Diffuser	31.5	69	30	33.3	71	30	34.3	71	30	36.7	71	30	41.2	73	29	43.8	75	29

GOLF ROTORS



752 Series Metric Performance Data

REAR-SPREADER NOZZLES																								
Spreader Nozzle Color	Flow (m ³ /h) (l/s)		Nozzle Range Main (m) Rear (m)		Flow (m ³ /h) (l/s)		Nozzle Range Main (m) Rear (m)		Flow (m ³ /h) (l/s)		Nozzle Range Main (m) Rear (m)		Flow (m ³ /h) (l/s)		Nozzle Range Main (m) Rear (m)		Flow (m ³ /h) (l/s)		Nozzle Range Main (m) Rear (m)					
	Pressure (bar)	4.8		5.5		4.8		5.5		4.8		5.5		4.8		5.5		4.8		5.5				
MAIN NOZZLE #18 – BEIGE																								
Orange	2.6	0.71	7.9	11.0	2.8	0.77	8.5	11.0	2.6	0.72	11.6	11.0	2.8	0.77	11.6	10.4	3.0	0.82	12.8	9.8	3.1	0.86	12.8	10.4
Green	3.2	0.88	7.9	15.8	3.3	0.92	8.5	15.8	3.5	0.97	10.4	15.2	3.7	1.03	11.0	15.8	3.7	1.03	12.2	15.8	4.0	1.10	12.2	15.8
Blue	3.2	0.90	7.9	14.6	3.5	0.96	7.9	14.6	3.5	0.98	11.0	14.6	3.8	1.05	11.0	13.4	3.8	1.05	12.8	14.0	4.1	1.13	12.8	14.0
Black	3.0	0.84	7.9	14.0	3.2	0.88	7.9	14.0	3.3	0.91	11.0	14.0	3.5	0.97	11.0	14.0	3.6	1.00	12.2	13.4	3.8	1.07	12.8	13.4
Red	2.8	0.78	7.9	15.2	2.9	0.81	7.9	15.8	3.0	0.84	11.0	15.2	3.2	0.90	11.0	15.8	3.3	0.93	12.2	15.2	3.6	1.00	12.2	15.2
Blue + Diffuser	2.5	0.68	7.9	10.4	2.6	0.71	8.5	10.4	2.8	0.77	11.0	10.4	2.9	0.81	11.6	10.4	3.1	0.85	12.2	9.8	3.2	0.90	12.2	10.4
Black+Diffuser	2.6	0.72	8.2	9.8	2.5	0.70	8.5	9.8	2.7	0.76	11.0	10.1	2.9	0.81	11.3	9.8	3.0	0.83	11.9	9.8	3.2	0.89	11.9	9.8
MAIN NOZZLE #20 – GRAY																								
MAIN NOZZLE #22 – RED																								
MAIN NOZZLE #24 – PLUM																								
MAIN NOZZLE #26 – LT. GREEN																								
MAIN NOZZLE #28 – WHITE																								
Orange	2.8	0.77	13.4	9.8	2.9	0.81	13.4	9.8	3.4	0.95	14.6	9.8	3.6	1.01	15.8	10.4	4.6	1.28	17.7	10.4	5.0	1.38	17.7	10.4
Green	3.6	1.00	13.4	15.2	3.8	1.07	14.0	15.2	4.2	1.18	14.6	15.2	4.5	1.26	15.2	15.8	5.4	1.50	17.1	15.2	5.7	1.58	17.1	15.2
Blue	3.7	1.02	13.4	14.0	3.9	1.09	13.4	14.0	4.3	1.19	15.2	14.0	4.6	1.27	15.2	14.0	5.5	1.53	17.1	12.8	5.9	1.63	17.1	12.8
Black	3.5	0.96	13.4	14.0	3.7	1.03	13.4	14.0	3.9	1.09	14.6	13.4	4.2	1.17	14.6	13.4	5.3	1.47	17.7	12.2	5.6	1.56	17.7	12.2
Red	3.2	0.89	14.0	15.2	3.5	0.96	14.0	15.2	3.8	1.06	14.6	15.2	4.0	1.12	14.6	15.8	5.1	1.41	18.3	15.2	5.4	1.49	17.7	15.2
Blue + Diffuser	3.0	0.82	14.0	10.4	3.1	0.87	13.4	10.4	3.5	0.96	15.2	10.4	3.7	1.03	15.2	10.4	4.9	1.35	18.3	10.4	5.1	1.43	18.3	10.4
Black+Diffuser	2.9	0.80	13.4	9.8	3.1	0.86	13.4	9.8	3.5	0.98	14.3	9.4	3.7	1.04	14.5	9.4	4.7	1.31	17.4	9.8	5.1	1.41	17.7	9.4
MAIN NOZZLE #32 – BLUE																								
MAIN NOZZLE #36 – YELLOW																								
MAIN NOZZLE #40 – ORANGE																								
Orange	5.1	1.42	19.5	9.8	5.5	1.52	19.5	9.8	5.7	1.58	20.1	9.8	6.1	1.69	20.1	9.8	6.4	1.78	20.7	9.1	6.8	1.90	20.7	9.1
Green	5.9	1.63	18.3	15.2	6.2	1.73	18.9	15.2	6.5	1.79	19.5	14.6	7.2	2.01	19.5	14.6	7.2	1.99	20.7	14.0	7.5	2.09	20.7	14.0
Blue	5.9	1.63	18.3	12.8	6.2	1.73	18.3	12.8	6.5	1.80	19.5	12.2	6.9	1.92	19.5	12.2	7.2	1.99	20.1	12.2	7.6	2.11	20.1	12.2
Black	5.8	1.61	18.3	11.6	6.2	1.71	18.3	12.2	6.4	1.78	19.5	11.6	6.7	1.87	19.5	11.0	8.8	2.44	20.1	11.6	7.5	2.08	20.7	11.6
Red	5.5	1.52	18.9	14.6	5.9	1.63	18.9	14.6	6.1	1.70	19.5	14.6	6.6	1.83	20.1	14.6	6.8	1.90	20.7	14.6	7.3	2.04	20.7	14.6
Blue + Diffuser	5.3	1.47	18.9	9.8	5.6	1.56	18.9	10.4	5.9	1.65	19.5	10.4	6.3	1.76	20.7	10.4	8.7	2.41	20.7	9.8	8.7	2.43	20.7	9.8
Black+Diffuser	5.2	1.44	18.6	9.4	5.5	1.54	18.6	9.4	5.9	1.63	19.5	9.4	6.2	1.73	20.1	9.4	6.5	1.79	20.4	9.1	7.0	1.94	20.7	9.1
MAIN NOZZLE #32 – BLUE																								
MAIN NOZZLE #36 – YELLOW																								
MAIN NOZZLE #40 – ORANGE																								
MAIN NOZZLE #44 – GREEN																								
MAIN NOZZLE #48 – BLACK																								
MAIN NOZZLE #50 – DK. BROWN																								
Orange	7.0	1.93	20.7	9.8	7.4	2.06	21.3	9.1	7.6	2.11	21.3	9.1	8.2	2.26	21.3	9.1	9.3	2.59	22.6	9.1	9.9	2.76	23.2	9.1
Green	7.6	2.12	20.7	14.0	8.2	2.28	21.3	14.0	8.2	2.28	20.1	14.0	8.8	2.44	21.3	14.0	9.9	2.75	21.9	12.8	10.5	2.91	22.6	12.8
Blue	7.9	2.19	20.7	11.6	8.3	2.31	21.3	11.6	8.4	2.33	20.1	10.4	9.1	2.52	20.7	11.0	9.9	2.74	21.9	11.0	10.6	2.93	22.6	11.0
Black	7.6	2.10	20.7	11.6	7.9	2.20	21.3	11.6	8.2	2.26	20.7	11.6	8.7	2.40	21.3	11.6	9.7	2.69	21.9	10.4	10.4	2.89	22.6	10.4
Red	7.4	2.05	20.7	14.6	7.8	2.18	21.3	14.6	7.9	2.20	21.3	14.0	8.5	2.37	21.9	14.0	9.6	2.67	21.9	13.4	10.2	2.83	22.6	13.4
Blue + Diffuser	7.1	1.98	21.3	9.8	7.7	2.13	21.9	9.8	7.9	2.18	21.3	10.4	8.2	2.27	21.9	10.4	9.4	2.62	22.6	9.8	10.0	2.79	23.2	9.8
Black+Diffuser	7.2	1.99	21.0	9.1	7.6	2.10	21.6	9.1	7.8	2.16	21.6	9.1	8.3	2.32	21.6	9.1	9.4	2.60	22.3	8.8	9.9	2.76	22.9	8.8

GOLF ROTORS

702 Series Rotors

SPECIFICATIONS

Radius: 59' to 77' (18.0 m to 23.5 m)

Flow Rate: 16.85 to 42.85 gpm (1.06 to 2.70 l/s); (3.83 to 9.73 m³/h)

Arc: Full-circle 360°

Models:

E: Electric

IC: Integrated Control

B: Block with Seal-A-Matic™ device

Maximum Inlet Pressure:

Models E and IC: 150 psi (10.3 bar)

Model B: 100 psi (6.9 bar)

Pressure Regulation Range: 60 to 100 psi (4.1 to 6.9 bar)

Factory Pressure Settings:

Models E and IC: Available in 70 and 80 psi (4.8 and 5.5 bar)

Dimensions:

Body Height:

Models E, IC: 12.0" (30.5 cm)

Model B: 9.6" (24.5 cm)

Pop-Up Height to Mid-Nozzle:

Models E, IC, B: 2.6" (6.6 cm)

Top Diameter:

Models E, IC: 6.25" (15.9 cm)

Model B: 4.25" (10.8 cm)

Nozzle Trajectory:

Standard: 25°

Wind Tolerant: 12°

Inlet Threads:

Models E, IC: 1.25" (32 mm) ACME female threaded

Models B: 1" (25 mm) ACME female threaded

Holdback:

Block: 17' (5.2 m) elevation

Rotation Time: 360° in ≤ 180 seconds; 160 seconds nominally

Maximum Stream Height:

Standard: 17' (5.2 m)

Wind Tolerant: 10' (3.1 m)

Solenoid: 24 VAC solenoid power requirement: 0.41 amp inrush current (9.8 VA);

60 cycle: 0.25 amp holding current (6.0 VA);

50 cycle: 0.32 amp holding current (7.7 VA)

Surge Resistance: Up to 25kV standard on electric models and 20kV on IC models.

Top-Serviceable Rock Screen™ and Replaceable Valve Seat:

On Models E, IC

Special Features:

Self-Adjusting Stator

Optional Sod Cup

GOLF ROTORS

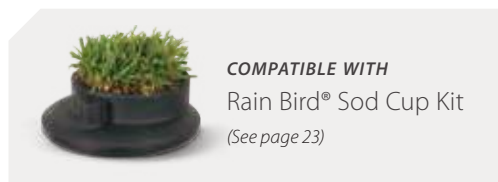

COMPATIBLE WITH
Rain Bird® Sod Cup Kit
(See page 23)

HOW TO SPECIFY

A	702	XX	XX	XX
THREAD TYPE	MODEL	BODY/ VALVE	PRESSURE REGULATOR	NOZZLE
ACME	702	E	70 (4.8)	28
		IC	80 (5.5)	32
		B		36
				40
				44
				48

NOTE: 28/32/36 main nozzles come with Blue/Black spreader nozzle combination and 40/44/48 main nozzles come with Black/Black spreader nozzle combination.



U.S. Performance Data

DUAL-SPREADER™ NOZZLES												
Base Pressure (psi)	50		60		70		80		90		100	
	Radius (ft)	Flow (gpm)	Radius (ft)	Flow (gpm)	Radius (ft)	Flow (gpm)	Radius (ft)	Flow (gpm)	Radius (ft)	Flow (gpm)	Radius (ft)	Flow (gpm)
#28 - White	59	16.9	60	18.8	62	20.3	62	21.5	63	22.7	65	24.2
#32 - Blue	62	20.6	63	22.1	65	23.3	67	25.0	69	27.3	69	28.7
#36 - Yellow	66	21.0	66	24.0	68	26.4	70	28.3	70	28.8	71	31.2
#40 - Orange	64	23.9	68	26.3	71	28.7	72	30.6	73	32.1	74	33.5
#44 - Green	—	—	69	29.0	73	31.8	75	33.9	75	35.6	75	37.2
#48 - Black	—	—	—	—	72	35.4	74	37.5	75	40.9	77	42.9

Metric Performance Data

DUAL-SPREADER™ NOZZLES																		
Base Pressure (bar)	3.4			4.1			4.8			5.5			6.2			6.9		
	Radius (m)	Flow (m ² /h)	Flow (l/s)	Radius (m)	Flow (m ² /h)	Flow (l/s)	Radius (m)	Flow (m ² /h)	Flow (l/s)	Radius (m)	Flow (m ² /h)	Flow (l/s)	Radius (m)	Flow (m ² /h)	Flow (l/s)	Radius (m)	Flow (m ² /h)	Flow (l/s)
#28 - White	18.0	3.83	1.06	18.3	4.26	1.18	18.9	4.61	1.28	18.9	4.88	1.36	19.2	5.14	1.43	19.8	5.50	1.53
#32 - Blue	18.9	4.67	1.30	19.2	5.01	1.39	19.8	5.29	1.47	20.4	5.67	1.57	21.0	6.20	1.72	21.0	6.51	1.81
#36 - Yellow	20.1	4.76	1.32	20.1	5.44	1.51	20.7	6.00	1.67	21.3	6.42	1.78	21.3	6.54	1.83	21.6	7.09	1.97
#40 - Orange	19.5	5.43	1.51	20.7	5.97	1.66	21.6	6.52	1.81	22.0	6.95	1.93	22.3	7.29	2.03	22.6	7.60	2.11
#44 - Green	—	—	—	21.0	6.59	1.83	22.3	7.23	2.01	22.9	7.71	2.14	22.9	8.09	2.25	22.9	8.44	2.34
#48 - Black	—	—	—	—	—	—	22.0	8.04	2.23	22.6	8.51	2.36	22.9	9.29	2.58	23.5	9.73	2.70



GOLF ROTORS

552 Block Rotors

SPECIFICATIONS

Radius: 33' to 55' (10.1 m to 16.8 m)

Flow Rate: 6.80 to 14.00 gpm (0.43 to 0.88 l/s); (1.54 to 3.18 m³/h)

Arc: Full-circle 360°; Adjustable 30° to 345°

Model:

B: Block with Seal-A-Matic™ device

Maximum Inlet Pressure: 100 psi (6.9 bar)

Dimensions:

Body Height: 9.6" (24.5 cm)

Pop-Up Height to Mid-Nozzle: 2.6" (6.6 cm)

Top Diameter: 4.25" (10.8 cm)

Nozzle Trajectory:

51 Nozzle: 12°

52, 53, 54 Nozzles: 25°

Inlet Threads: 1" (25 mm) ACME female thread

Holdback: 17' (5.2 m) elevation

Rotation Time: 180° in ≤ 90 seconds; 80 seconds nominally

Maximum Stream Height:

51 Nozzle: 5' (1.5 m)

52, 53, 54 Nozzles: 13' (4.0 m)

Special Features:

Self-Adjusting Stator

Low Flow-by Bearing Guide

HOW TO SPECIFY

A	-	552	-	XX	-	XX
THREAD TYPE		MODEL		BODY/ VALVE		NOZZLE
ACME		552		B		51 52 53 54

Turn-of-a-Screw Adjustments

The same time-saving Rapid-Adjust Technology as the 752, now available on the 552.

(See page 14 for details)



GOLF ROTORS

U.S. Performance Data

Base Pressure (psi)	50		60		70		80		90		100	
	Radius (ft)	Flow (gpm)	Radius (ft)	Flow (gpm)	Radius (ft)	Flow (gpm)	Radius (ft)	Flow (gpm)	Radius (ft)	Flow (gpm)	Radius (ft)	Flow (gpm)
#51-Blue	33	6.8	34	7.4	35	8.0	36	8.5	37	8.8	37.5	9.3
#52-Beige	37	6.7	39	7.2	37	8.1	37	8.2	39	8.7	39	9.3
#53-Gray	51	9.3	51	10.1	51	11.0	51	11.7	51	12.5	51	13.2
#54-Red	—	—	—	—	53	12.0	54	12.4	55	13.3	55	14.0

Metric Performance Data

Base Pressure (bar)	3.4			4.1			4.8			5.5			6.2			6.9		
	Radius (m)	Flow (m ³ /h)	Flow (l/s)	Radius (m)	Flow (m ³ /h)	Flow (l/s)	Radius (m)	Flow (m ³ /h)	Flow (l/s)	Radius (m)	Flow (m ³ /h)	Flow (l/s)	Radius (m)	Flow (m ³ /h)	Flow (l/s)	Radius (m)	Flow (m ³ /h)	Flow (l/s)
#51-Blue	10.1	1.54	0.43	10.4	1.68	0.47	10.7	1.82	0.50	11.0	1.93	0.54	11.3	2.00	0.56	11.3	2.11	0.59
#52-Beige	11.3	1.52	0.42	11.9	1.64	0.46	11.3	1.83	0.51	11.3	1.87	0.52	11.9	1.99	0.55	11.9	2.11	0.59
#53-Gray	15.5	2.12	0.59	15.5	2.29	0.64	15.5	2.49	0.69	15.5	2.65	0.73	15.5	2.83	0.79	15.5	2.99	0.83
#54-Red	—	—	—	—	—	—	16.2	2.72	0.75	16.5	2.82	0.78	16.8	3.01	0.84	16.8	3.18	0.88



Features	952	752	702	552
Radius	70' to 101' (21.3 m to 31.8 m)	30' to 84' (9.1 m to 25.6 m)	59' to 77' (18.0 m to 23.5 m)	33' to 55' (10.1 m to 16.8 m)
Flow Rate	19.7 to 54.5 gpm (1.24 to 3.44 l/s) (4.43 to 12.38 m ³ /h)	6.8 to 47.0 gpm (0.43 to 2.97 l/s) (1.54 to 10.68 m ³ /h)	16.85 to 42.85 gpm (1.06 to 2.70 l/s) (3.83 to 9.73 m ³ /h)	6.80 to 14.00 gpm (0.43 to 0.88 l/s) (1.54 to 3.18 m ³ /h)
Arc	Full-circle 360° Adjustable 30° to 345°	Full-circle 360° Adjustable 30° to 345°	Full-circle 360°	Full-circle 360° Adjustable 30° to 345°
Models	Full- and Part-Circle 952E: Electric 952IC: Integrated Control 952SAM: Stopamatic	Full- and Part-Circle 752E: Electric 752IC: Integrated Control 752B: Seal-A-Matic	Full-Circle 702E: Electric 702IC: Integrated Control 702B: Seal-A-Matic	Full- and Part-Circle 552B: Seal-A-Matic™
Maximum Inlet Pressure	Models E and IC: 150 psi (10.3 bar) Model SAM: 100 psi (6.9 bar)	Models E and IC: 150 psi (10.3 bar) Model B: 100 psi (6.9 bar)		100 psi (6.9 bar)
Pressure Regulation Range	Models E and IC: 60 to 100 psi (4.1 to 6.9 bar)	60 to 100 psi (4.1 to 6.9 bar)		—
Factory Pressure Settings	E and IC: Available in 70 and 80 psi (4.8 and 5.5 bar)	E and IC: Available in 70 and 80 psi (4.8 and 5.5 bar)		—
Body Height	13.4" (34.0 cm)	Models E, IC: 12.0" (30.5 cm) Model B: 9.6" (24.5 cm)		9.6" (24.5 cm)
Pop-Up Height	2.6" (6.6 cm)	2.6" (6.6 cm)		2.6" (6.6 cm)
Top Diameter	7.00" (17.8 cm)	Models E, IC: 6.25" (15.9 cm) Model B: 4.25" (10.8 cm)		4.25" (10.8 cm)
Nozzle Trajectory	Standard: 25° Low Angle: 17°	Standard: 25° Wind Tolerant: 12° Low Angle: 15°	Standard: 25° Wind Tolerant: 12°	51 Nozzle: 12° 52, 53, 54 Nozzles: 25°
Inlet Threads	1.5" (38 mm) (15/21) ACME female threaded	Models E, IC: 1.25" (32 mm) ACME female threaded Model B: 1" (25 mm) ACME female threaded		1" (25 mm) ACME female threaded
Holdback	SAM: 17' (5.2 m) elevation	Block: 17' (5.2 m) elevation		17' (5.2 m) elevation
Rotation Time	180° in ≤ 100 seconds; 80 seconds nominally	180° in ≤ 90 seconds; 80 seconds nominally	360° in ≤ 180 seconds; 160 seconds nominally	180° in ≤ 90 seconds; 80 seconds nominally
Maximum Stream Height	Standard: 22' (6.7 m) Low Angle: 12' (3.7 m)	Standard: 17' (5.2 m) Wind Tolerant: 10' (3.1 m) Low Angle: 12' (3.7 m)	Standard: 17' (5.2 m) Wind Tolerant: 10' (3.1 m)	51 Nozzle: 5' (1.5 m) 52, 53, 54 Nozzles: 13' (4.0 m)
Solenoid	24 VAC solenoid power requirement, 20kV on IC models	24 VAC solenoid power requirement, 20kV on IC models		—
Surge Resistance	25kV standard on electric models	Up to 25kV standard on electric models		—
Top-Serviceable Rock Screen™ and Replaceable Valve Seat	E, IC, SAM	E, IC		—

Swing Joints

Featuring a swept elbow design that extends the life of your swing joint, superior flow characteristics and excellent structural integrity, these swing joints are designed to deliver performance you expect from Rain Bird while saving you money.

SPECIFICATIONS

Diameter: 1" (2.5 cm), 1 ¼" (3.2 cm) and 1 ½" (3.8 cm)

Lay Arm Lengths: 8" (20.3 cm), 12" (30.5 cm) and 18" (45.7 cm)

Inlet Type: NPT, BSP, ACME, AquaFuse® AquaSaddle, and spigot

Outlet Thread Type: NPT, BSP or ACME

Enlarging NPT, BSP or ACME Outlets: Available on 1" (2.5 cm) and 1 ¼" (3.2 cm) swing joints for connections to many rotors with 1 ¼" (3.2 cm) and 1 ½" (3.8 cm) inlet sizes respectively (no additional adapters required)

Inlet Configurations: Standard side or top-mount connections to lateral lines

Outlet Configuration: Single-top or triple-top for added rotor positioning flexibility

Pressure Rating: 315 psi (21.7 bar) at 73°F (22.8°C)

Reducing ACME Inlet: Available on 1 ¼" (3.2 cm) diameter swing joints for connection to a 1 ½" (3.8 cm) ACME service tee

Superior Flow Characteristics. An innovative swept elbow design reduces pressure loss by up to 50 percent over other swing joints.

Excellent Structural Integrity. Reduces the costs associated with fatigue-related failures.

Double O-ring Protection. Provides a better seal to ensure that joints are kept clean and can be repositioned easily.

Modified ACME Outlet. Improves safety by losing seal engagement before losing thread engagement during rotor removal.

Oversized Threaded Inlets. Make hand-tightening and blind installations (underwater) easier. This also reduces the risk of potential damage caused by over-tightening with a wrench.

Extended Warranty. When used with Rain Bird golf rotors, extends rotor and swing joint warranty to five years.



ALSO AVAILABLE

NPT and BSP ACME Adapters

If you currently have NPT or BSP swing joints, you can now enjoy the benefits of ACME-threaded rotors by utilizing a Rain Bird NPT-ACME or BSP-ACME side of the adapter. Just screw the adapter into the inlet on the ACME case, and then screw the rotor with the adapter onto the NPT or BSP swing joint until it is snug.



AquaFuse® AquaSaddle Inlet



Directly connect Rain Bird Swing Joints to AquaFuse AquaSaddle without the need for a separate adapter.



Swing joints featuring Aquasaddle Inlets are offered in various configurations, including lay arm lengths of 8", 12", and 18". Additionally, these swing joints are available in diameters of 1", 1.25", and 1.5".

Service Tools

Rain Bird offers a full line of quality tools for the service and maintenance of Rain Bird golf rotors. Constructed of heavy-duty metal alloys and durable plastic, these tools are lightweight and easy to use.



D02203 – Snap-Ring Pliers 900/950/952



Y05100 – Rotor Tool



B41720 – Selector Service Tool/Key



D02236 – Snap-Ring Pliers
551/552/700/702/751/752



D02237 – Installation Socket for
Top-Serviceable Rock Screen



D05205 – Universal Hose Adapter



B41730 – Valve Insertion Tool 900/950/952



D02215 – 7" Selector Valve Key



B41710 – Valve Insertion Tool
551/700/702/751/752



D02221 – 18" Selector Valve Key



Sod Cup Kit

Enhance the playability and appearance of your course with easy-to-install sod cups. Turf growth directly on top of the rotor eliminates the need to trim around heads while keeping it easily accessible for service.





Somerset Hills Country Club

IC System™

A Revolutionary, Yet Simple Approach to Field Control.

Achieving optimal playing conditions isn't so much an issue of working harder, it's working smarter. Add the Rain Bird intelligent and intuitive IC System with IC CONNECT™ and you're on your way. Communicate directly with every rotor on your course, and gain one-of-a-kind property management with IC CONNECT. With an intuitive interface operated from a computer, tablet or mobile device, the IC System puts control in your hands, anywhere.



Streamlined Installation and Expansion

- Cut installation cost and time by eliminating unneeded wire, trenching and splices.
- Minimize labor costs during expansion by simply connecting new IC Rotors to any existing MAXI™ Cable.

Pinpoint Diagnostics and Control

- 45 seconds for 1000+ stations.
- Narrow in on potential problems and resolve issues quickly to prevent turf damage and unnecessary labor costs.
- Bring greater precision and water savings to areas requiring supplemental watering (hot spots, greens, grow-ins).

IC Rotors and Valves

SPECIFICATIONS

System Capacity*: 750 ICMs per Output Wire Path, 1,500 ICMs per Output Driver Board, 3,000 ICMs per IC Interface (ICI), up to 36,000 ICMs with Cirrus™

ICI Electrical Specifications:

115 VAC: Nominal 98-132 VAC

220-240 VAC: Nominal 208-255 VAC

100 VAC: Nominal 91-110 VAC

Electrical Output: 28.5 VAC, 1.25 AMP Per Wire Path

Active Stations: No electrical limit — only limited by hydraulics of pipe network and size of pump station

ICM Current Requirements: Varies based on wire path length — Nominal Current Draw is 0.33 mA on 5,000 feet (1,500 meters) of wire

Grounding Requirements: Integrated Control Surge Device (ICSD) to be grounded to 50 ohms or less every 500 feet (150 meters) or 15 ICMs, whichever is less. The central control to be grounded to 10 ohms or less of resistance

Compliance: CE, FCC, UL

Environment:

Working Range: 32° F to 122° F (0° C to 50° C)

Storage Temperature: -40° F to 150° F (-40° C to 65° C)

Operating and Storage Humidity: 100%

Dimensions:

ICM: 2.23" x 1.70" (57 mm x 43 mm)

ICSD: 2.00" x 1.41" (51 mm x 43 mm)

Compatibility: Rain Bird® 500/550 Series Rotors, Rain Bird® 551 Series Rotors, Rain Bird® Valve-in-Head Rotors, Rain Bird® 700/751 Series Rotors, Rain Bird® 702/752 Series Rotors, EAGLE™ 700 and 900 Series Rotors**, Rain Bird® 900 Series Rotors, Rain Bird® 952 Series Rotors and Rain Bird® PEB, PESB, PESB-R, PGA, EFB, BPE and BPES electric valves

Maximum Wire Paths:

Cirrus: 12 interfaces, 48 wire paths

Nimbus™: 8 interfaces, 32 wire paths

Stratus™ II: 2 interfaces, 8 wire paths

StratusLT™: 1 interface, 1 wire path

* Specific System Capacity is dependent on the central control system

** NOTE: EAGLE™ Rotors sold before 6/2009 will have a random orientation of the ICM relative to the Selector Housing

HOW TO SPECIFY — ROTORS

A	XXX	IC	XX	XX
THREAD TYPE	MODEL	BODY	PRESSURE REGULATOR	NOZZLE
ACME	552 702 752 952	IC	70 (4.8) 80 (5.5)	See nozzle charts for each rotor model.

For exact combinations of rotors (nozzles and pressure regulator), see pages 10–23 for correct model.

HOW TO SPECIFY — VALVES

GSVIC	XXX
MODEL	SIZE
GSVIC	100 = 1" NPT 200 = 2" NPT 101 = 1" BSP 201 = 2" BSP 150 = 1½" NPT 211 = 2" BSP (brass) 151 = 1½" BSP

NOTE: IC Valve Kit must be ordered separately. See page 27 or visit rainbird.com/ICRotors.

For exact combinations of valves (size), see pages 52–59 for correct model.



IC Module

FEATURES AND BENEFITS

Timeless Compatibility™. The Integrated Control Module (ICM) is compatible with all Rain Bird golf rotors, making hardware and software updates simple and easy.

Simple to Install. Requires up to 90% less wire than traditional satellite control systems and 50% fewer splices than a traditional decoder system.

Cost Savings. Fewer splices and less wire require less time and effort to install the system.

System Database Management. The ICM offers a tear-off bar code for easy scanning into the central control system database. As soon as the ICM is connected to a live wire path with address entered, the station is operational.

Reliable Control. The IC System is a simple yet sophisticated controller. Built using Rain Bird's proven solenoid technology with on board computer redundancy.

Easier to Design. The IC System is easier to design – only simple calculations are required. It eliminates an array of troublesome considerations – there are no controllers to design around or conceal and no looped wires.

Easier Maintenance. The IC System is capable of intelligent, two-way communication with each and every ICM and IC CONNECT on the golf course.

Dependable. The IC System is designed to always turn off if problems occur. When the wire path is damaged or cut, or if central control communication is lost, the ICM is designed to turn off automatically with built-in redundancy.

True "Below 30-Volt Control System". As the IC System wire path output is 28.5 Volt, the IC System is a "true less than 30-Volt" control system. A lower than 30-Volt system is considered a low-voltage system and is typically not subjected to code requirements regarding deep burial of the wire path.

Below Ground Control. Since the ICM is built right into the rotor or valve, the entire control system is below ground. Unlike field controller systems, the below-ground system offers protection against damage from vandalism, flooding and wildlife.

Golf Course Aesthetics. Since the IC System control is designed to be entirely below ground, the golf course vistas are clear of irrigation components as envisioned by the golf course designer.

Central Control "Smart Features". With the IC System, you have the ability to utilize all of Rain Bird® Central Control "Smart Features" including: Minimum ET,™ Smart Weather,™ Smart Pump™ mapping with custom graphics, and superior monitoring of system operation.

Surge Resistance. Each ICM has 20kV of onboard surge resistance standard.

IC Valve Kit For your existing solenoid valves, you can get the Integrated Control Module and valve adapter preassembled and ready for installation with the IC Valve Kit.



For full IC Module specification details, visit rainbird.com/ICRotors.

For information regarding the IC System Wire Path Design, see the table in the Appendix, page 102.

IC CONNECT™

IC CONNECT allows you to feed more data into your system with IC-IN and remotely control field equipment using IC-OUT.

FEATURES AND BENEFITS

Simple and Elegant Design. IC-IN can be connected to any IC System MAXI™ Cable path (wire path can be shared with multiple ICM, IC-OUT or IC-IN devices).

- Each IC-IN is equivalent to 15 ICMs and each IC-OUT is equivalent to 1 ICM towards the maximum 750 ICMs per MAXI wire path
- Each IC-IN and IC-OUT is equivalent to 1 ICM for determining placement of ICSD surge protection devices
- Built-in 20kV surge protection

Hybrid Capabilities. When connected to an ICI+ interface, IC-IN and IC-OUT can be used in a hybrid design configuration with Satellite field controllers and/or decoders.

SPECIFICATIONS

Environment:

Operating Temperature: 14° F to 125° F (-10° C to 51° C)

Storage Temperature: -40° F to 150° F (-40° C to 65° C)

Operating and Humidity: 75% max at 40° F to 180° F (4° C to 42° C)

IC System™ Field Wiring Voltage: 26-28.5 VAC (max)

Dimensions:

Excluding Wires: 3.71" x 2.70" x 1.66" (94 mm x 69 mm x 42 mm)

Wire Length: 24" (61 cm)

Sensor Types Supported:

Voltage: 0-10VDC

Current: 4-20mA DC

IC-IN Contact Closure:

Pulse Counting: 50% duty cycle 1kHz (max)

Pulses in 10 Seconds: 50% duty cycle 1kHz (max)

Pulses per Second: 50% duty cycle 1kHz (max)

Wiring Connections:

Red: MAXI Cable Red

Black: MAXI Cable Black

Red/White:

IC-IN: Sensor (+)

IC-OUT: Output (+)

Black/White:

IC-IN: Sensor (-)

IC-OUT: Output (-)

IC-IN

Collect information from multiple field sensors:

- Rain cans
- Flow sensors
- Lake level sensors

HOW TO SPECIFY

IC	-	IN
MODEL		INPUT/OUTPUT
IC		IN



Simplified Design

By eliminating up to 90% of the wire* and all decoders and satellites, IC System protects the aesthetics of your course while streamlining installation, maintenance and expansion.

*Compared to satellite systems

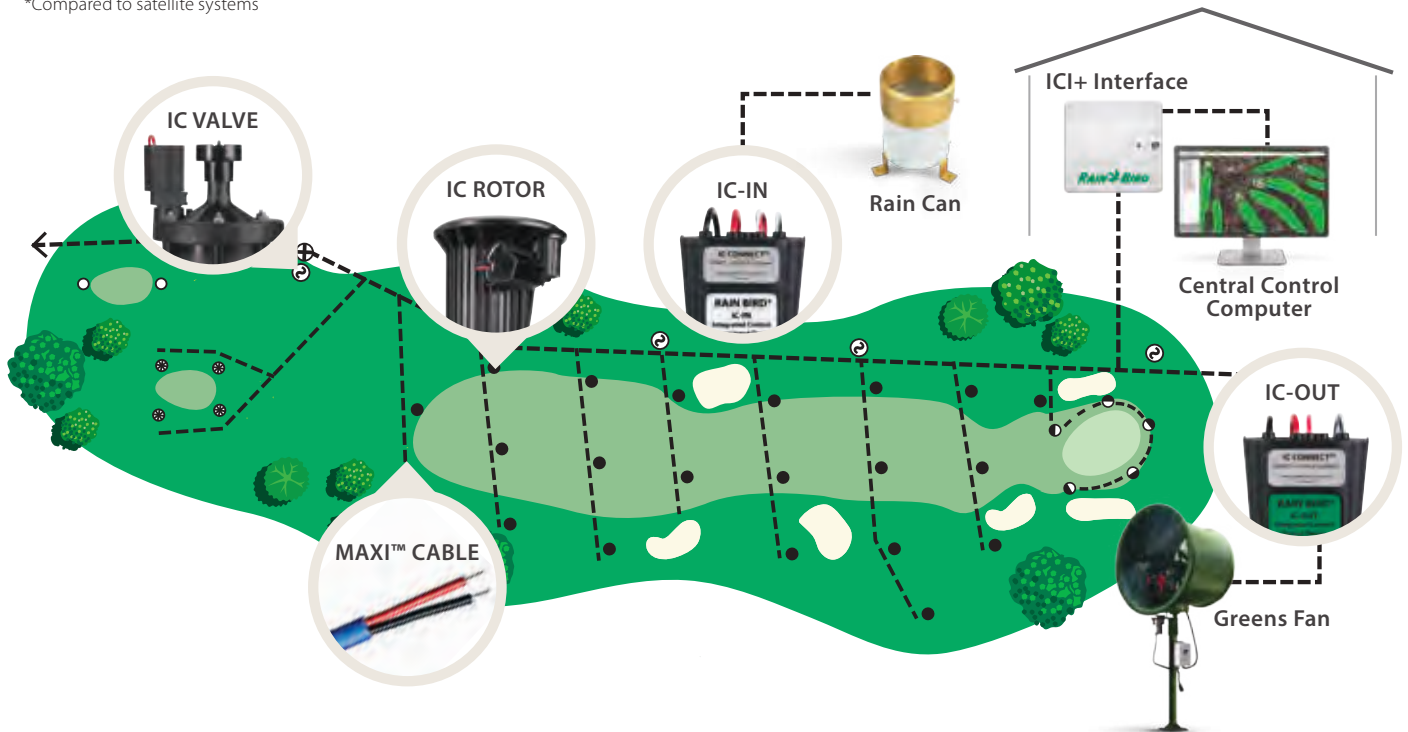

IC-OUT

Centralize ON and OFF control of non-irrigation products around the facility:

- Transfer pumps
- Greens fans
- Fountains and water features
- Lighting

HOW TO SPECIFY

IC	—	OUT
MODEL		INPUT / OUTPUT
IC		OUT



Medalist Golf Club

Field Control

Unparalleled Compatibility. Unmatched Quality.

Compatible with any Rain Bird® Central Control system, Rain Bird field control delivers the trusted performance that golf course professionals rely on to maximize course appearance and playability. From best-in-class satellite systems to reliable field decoders, you'll get a full range of solutions that make irrigation scheduling, adjustments and maintenance easier.



Easy to Use

From pre-coded addressing for easy installation of decoders to the modular configuration for easy expansion on PAR+ES controllers, Rain Bird field controllers are designed for easier installation, programming and expansion.

Proven Performance

Every Rain Bird field controller is built and tested to endure decade after decade. Controllers feature premium surge protection, extensive diagnostics and a best-in-class pedestal enclosure. Decoders are no exception with industry proven surge containment and water-tight housing.



PAR+ES Controller

The easy-to-program Rain Bird® PAR+ES Controller is compatible with any Rain Bird® Central Control system and any other Rain Bird Controller. It features up to 72-Station capability, unlimited programs with central control, premium surge protection, extensive diagnostics and best-in-class pedestal enclosure.

FEATURES AND BENEFITS

Communication. Standalone, two-wire and LINK™.

Central Control Ready. Works with any Rain Bird® Central Control system. End-users can access controller via The MI Series™ Mobile Controller* or FREEDOM System™.

- Dynamic Flo-Manager®
- Smart Pump™
- Smart Sensor™
- Smart Weather™

Easy to Use. Large, raised control buttons with clear, descriptive icons and a high-contrast Liquid Crystal Display (LCD) panel make programming easy. Lights indicate active schedules and central control status, while unique copy/paste function speeds programming process. An angled keypad aids visibility as well as water drainage, and makes the PAR+ES controller extremely easy to use.

Greater Water Precision. The PAR+ES controller allows you to program six (6) automatic and two (2) manual schedules. It allows you to turn on a maximum of 16 solenoids at 60 Hz and 12 solenoids at 50 Hz, and features four (4) control modes — giving you ample programming and operating control.

Modular Configuration Allows Easy Expansion. The PAR+ES is available in any configuration and can be easily upgraded in 8-station increments. By simply plugging in an 8-station Output Station Module (OSM) you can expand your PAR+ES controller capabilities to accommodate any configuration.

Multi Manual with Station and Program Stacking. Perfect for syringing or putting down fertilizer, multi manual allows you to manually launch up to 16 stations at one time. Split second delayed start prevents water hammer and high inrush current.

Multiple Schedule Operation. No schedule limit when operated with Rain Bird Central Control systems.

Universal Performance Simplifies Installation and Operation. The intuitive PAR+ES Controller reduces installation and training hassles with its many universal features. For quick electrical hookups, the system automatically senses and adjusts for either a 50 or 60 Hz current; while one (1) transformer accommodates 100 V/120 V, 220 V or 230 V/240 V with the flip of a switch. The PAR+ES Controller also displays system activities and accepts user input in eight (8) different languages. The icon-driven controls and multilingual display eliminate confusion and translation problems.

Mix and Match. Mix and match with any other Rain Bird Controller and with any Rain Bird Central Control system.

Enclosed Electronics. Provides the best protection against the elements.

16-Solenoid Simultaneous Operation. Heavy-duty transformer permits simultaneous operation of up to 16 solenoids (12 at 50 Hz).

Irrigation Control. Variable or weekday programming, for weekday cycle or for irrigation every other day, every three (3) days or up to every nine (9) days.

Water Budget. Increase or decrease run times on a schedule in 10% increments from 0 to 200%.

Simplified Installation. Supplied templates make install easier.

Front Panel Lighting. Illumination LEDs and backlit faceplate buttons make programming easy even in poor lighting.

Large Capacity Terminal Strip. Accepts up to two (2) 14-gauge wires per station.

Standard Station Lights and Switches. OSM lights provide easy identification of active stations — turn stations on or off quickly for easy operation and troubleshooting.

Premium Surge Protection. Premium surge protection included in all models.

Sensor Response. Sensor activation cancels irrigation at controller.

Master Valve Activation. Activate master valve output with station activation.

Available PAR+ES Retro Kit. Extends the useful life of older satellites by converting to PAR+ES water-saving technology (see page 33).

The flexible PAR+ES can be ordered in the following configurations:

- PAR+ES standalone controller in a plastic pedestal.
- PAR+ES satellite with two-wire module in a plastic pedestal.
- PAR+ES satellite with LINK (wireless) module in a plastic pedestal.

All configurations are offered with a weather-proof and impact-resistant plastic pedestal.

Buy only the control you need today, and increase your operating capabilities or change your communication method at any time.

*Software required

HOW TO SPECIFY			
PAR ES	- XX	- X	S
MODEL PAR ES	STATION COUNT	CONFIGURATION	OSM TYPE
	16 [‡] 24 32 [‡] 40 48 56 [‡] 64 72	Blank = Standalone 2 = Two-wire L = LINK**	S = OSMs with Station Switches

NOTE: Expandable up to 72-Station count by adding OSMs.
**LINK Radios must be ordered separately from controller.
‡ Only options available in standalone configuration.



SPECIFICATIONS

Station Capacity: 72 stations, up to 16 solenoids operating simultaneously (60 Hz) (12 @ 50 Hz)

Electrical Input: (50/60 Hz); 117 VAC Nominal 98 to 132 VAC; 220 VAC Nominal 208 to 232 VAC; 240 VAC Nominal 225 to 255 VAC

Electrical Output: 26.5 VAC, 5.25 AMP

Station Load Capacity: Up to four (4) 24 VAC, seven (7) VA solenoids per station

Plastic Pedestal Dimensions:

Width: 17" (43.2 cm)

Height: 34 3/4" (88 cm)

Depth: 21" (53.4 cm)

Programs: As many programs as possible with Rain Bird Central Control Systems or six (6) automatic (12 start times each) and two (2) manual in standalone mode

Water Budget: 0 to 200% in 10% increments



Station Runtimes: One (1) to 120 minutes, in one (1) minute increments

Languages: English, French, German, Italian, Japanese, Portuguese, Spanish and Dutch

Grounding Requirements: Less than 10 ohms

Compliance: UL & C-UL Listed, CE approved, C-Tick Compliant and FCC

PAR+ES Retro Kit

The PAR+ES Retro Kit is the perfect controller upgrade for low budget retrofit to extend the life of your irrigation system.

FEATURES

Installation: Installs in any existing Rain Bird small plastic or stainless steel pedestal.

Versatile Configurations: Available as standalone, hardwired¹ or wireless². Hardwired and wireless configurations have real-time two-way communication with central control. In wireless mode, up to four controllers can share a single radio.

Expandable: 16-station configuration up to 48-station using plug-in 8-station output station modules with switches and station LED.

SPECIFICATIONS

Water Budget: 0 to 200% in 10% increments

Station Runtimes: One (1) to 120 minutes, in one (1) minute increments

Configurations: Standalone, hardwired and wireless

Programs: No limit with Rain Bird Central Control systems. Six (6) automatic (12 start times each) and two (2) manual programs

Schedule: Variable day watering (up to nine (9) days), custom day-of-the-week by program

Electrical Input: 117 VAC ±10% (60 Hz); 220 VAC (50 Hz)

Electrical Output: 26.5 VAC, 3 AMP

Station Load Capacity: Up to four (4) 24 VAC, seven (7) VA solenoids per station

Languages: English, French, German, Italian, Japanese, Portuguese, Spanish and Dutch

¹Requires interface module not included.

²Requires additional transformer.

PAR+ES Sat Decoder Controller

The PAR+ES Sat Decoder combines the features and benefits of a satellite controller with those of a decoder system. The advantages include:

- Easy Installation
- Reduced Installation Costs
- Easy Expansion

The Idea is Simple:

- Install the controller.
- Install a single two-wire path to control all the sprinklers.
- Install decoder between wire path and each sprinkler head.
 - Uses up to 80 percent fewer wires than conventional controllers
 - Built-in diagnostic tools
 - Compatible with all Rain Bird Golf Decoders (FD-101, FD-102, FD-202, FD-401 and FD-601)
 - Simply attach new decoder to the wire path
 - Operates as a standalone controller or add a Rain Bird® Central Control system for greater control
 - Operates up to 72 decoder addresses
- Program controller with decoder address.

SPECIFICATIONS

Station Capacity: 72 decoder addresses, up to 16 solenoids operating simultaneously (60 Hz)

Configurations: Standalone, two-wire and LINK

Electrical Input: (50/60 Hz); 115 VAC Nominal 98 – 132 VAC; 220 VAC Nominal 208 – 232 VAC; 240 VAC Nominal 225 – 255 VAC

Electrical Output: 26.5 VAC, 5.25 AMP

Station Load Capacity: Up to two (2) 24 VAC, seven (7) VA solenoids per station depending on decoder type

Plastic Pedestal Dimensions:

Width: 17" (43.2 cm)

Height: 34¾" (88 cm)

Depth: 21" (53.4 cm)

Programs: As many programs as possible with Rain Bird® Central Control systems or six (6) automatic (12 start times each) and two (2) manual in standalone mode

Water Budget: 0 – 200% in 10% increments

Station Runtimes: One (1) – 120 minutes, in one (1) minute increments

Languages: English, French, German, Italian, Japanese, Portuguese, Spanish and Dutch

Grounding Requirements: Less than 10 ohms

Compliance: UL & C-UL Listed, CE approved, C-Tick Compliant and FCC

Maximum Wire Length Between Controller and Decoder:

#12 AWG:

Star Design: 3.8 miles (6.1 km)

Loop Design: 15.2 miles (24.4 km)

#14 AWG

Star Design: 2.4 miles (3.8 km)

Loop Design: 9.6 miles (15.2 km)

Maximum Wire Length Between Decoder and Rotor: 456 ft (#14 AWG)

Maximum Wire Paths: Four (4), plus multiple branches per wire path



HOW TO SPECIFY

PAR ES-DEC - X - 72

MODEL	CONFIGURATION
PAR ES	Blank = Standalone
	2 = Two-wire
	L = LINK*

*LINK Radios must be ordered separately from controller.

Decoders

A proven technology on golf courses around the world, Rain Bird decoders provide best-in-class field control on centrally controlled irrigation systems. Installed underground and featuring simple, low-cost wiring, decoders are an aesthetically pleasing, full-featured, economical option for reliable in-field control.

FEATURES AND BENEFITS

- Improve aesthetics and reduce costs with buried in-field controls.
- Easy system expansion — simply splice into the communication line and add additional decoders.
- Installation requires up to 80 percent less wire than conventional controller systems.
- Electronic components are completely encapsulated to protect against the elements.
- Underground decoders reduce the chance of damage from wildlife, vandals or natural disasters.
- Pre-coded addressing eliminates confusion associated with switch-based addressing.
- With the addition of Rain Bird's Decoder Programming Unit (DPU), decoder addresses can be reassigned if necessary.

A Cost-Effective Alternative

A simple wiring configuration and absence of valve boxes keeps installation and maintenance costs low. Rain Bird decoders are a "true lower than 30 Volt" system that utilize a two-wire path of 14-gauge wire connecting the central control system, decoders and valves or valve-in-head sprinklers.

Simple, Reliable Control

If you're looking for an alternative to satellites, Rain Bird decoders may be the right solution for you. These decoders for your central control system are simple, robust and reliable. They work with your central control system just like satellites but are buried underground away from the elements.

Sensor Capability

If you need information from analog, pulse or switch sensors to manage your irrigation, connect the sensor to the SD-211 sensor decoder and view the data at the central. Using Smart Sensor™, sensor data can even be used to control the irrigation.

Excellent for Renovations

Thanks to advanced central control technology and simple wiring requirements, decoders are a smart choice for many golf course renovations. Using Cirrus™, Nimbus™ II, and Stratus™ II Central Control systems with Rain Bird's hybrid feature capabilities, Field Control systems and IC can be mixed and matched on one computer. This makes it easy to expand irrigation coverage using a minimal amount of wire and decoders.

* Additional software required

Protect Against the Elements

With all electronic components fully sealed within a water-tight enclosure and buried underground, damage from floods, frost, rodents or vandals is virtually eliminated. Rain Bird decoders are an especially good choice for flood plains.

An Out-of-Sight Solution

Buried decoder systems leave nothing exposed to the elements. With no evidence of in-field control, this aesthetically pleasing alternative works perfectly in situations where satellites are unwanted or impractical.

In-Field Control Options

The addition of decoders doesn't mean the elimination of in-field control. Decoders can be turned on and off in the field with The FREEDOM System™ or MI Series™ mobile controllers*. The MI Series mobile controller allows precise control of the decoder system anywhere Internet access is available. Another alternative is The FREEDOM System. This handheld radio remote allows you to signal changes to the central control system from anywhere on the course.

The Right Amount of Control

Select different decoders to operate one, two, four or six solenoids. Five different decoders let you choose the amount of control you need.

HOW TO SPECIFY

FD - XXX

MODEL	DECODER TYPE
101	Single Address (1 solenoid)
102	Single Address (up to 2 solenoids)
202	Dual Address (up to 4 solenoids)
401	Four Addresses (up to 4 solenoids)
601	Six addresses (up to 6 solenoids)



Maximum Critical Path Lengths for Two-Wire Paths

Nominal Wire Size	ohms/1000' ohms/Km	Loop (Nominal Wire Size)		Star	
		Km	Miles	Km	Miles
2.5 mm**	15.00 ohms/Km	12.0	7.5	3.0	1.8
14 AWG	2.58 ohms/1000*	15.2	9.6	3.8	2.4
12 AWG	1.62 ohms/1000*	24.4	15.2	6.1	3.8
10 AWG	1.02 ohms/1000*	39.2	24.4	9.8	6.1

Characteristic Table for Various Decoder Models

Decoder Model	Number of Address per Decoder	Maximum Number of Solenoids per Address	Maximum Addresses Operating at Once	Current Draw (mA at Rest per Decoder)
FD-101	1	1	1	0.5 mA
FD-102	1	2	1	0.5 mA
FD-202	2	2	2	1.0 mA
FD-401 *	4	1	4	1.0 mA
FD-601 *	6	1	4	1.0 mA

Design Criteria

Condition	Cirrus™	Nimbus™ II	Stratus™ II	StratusLT™
Maximum resistance in critical path	33 ohms	33 ohms	33 ohms	33 ohms
Maximum number of addresses per wire path **	250	250	250	200
Maximum number of addresses per LDI	500	500	500	300
Maximum number of addresses per SDI	200	200	200	200
Maximum number of active solenoids per wire path	20	20	20	15
Recommended interface unit	LDI	LDI	LDI	SDI
Maximum number of active solenoids per recommended interface ^Δ	40	40	40	15
Golf Black Solenoid (GBS25)	20 mA	20 mA	20 mA	20 mA
Hybrid system max number of interfaces per system (LDI, SDI)	12	8	2	1

Maximum Wire Lengths for Secondary Path Wire Runs

Wire Size	1.5 mm**	2.0 mm**	2.5 mm**	16.0 AWG	14.0 AWG	12.0 AWG
Meters	100	133	166	88	139	220
Feet	328	436	545	289	456	720

* Has LSP-1 surge protection built-in. ** A wire path is the leg coming off the LDI, SDI or LTB. ΔThe number of decoders on a large system with long wire runs may reduce the number of active decoders that you will be able to operate at one time before the interface maximum current draw is exceeded and the interface shuts down (disconnects from the field wiring).

WC100 Wire Connectors

Install Faster

When your installation crew is making countless wire connections on a jobsite, why slow them down with unnecessary work steps? Use Rain Bird® Wire Connectors to get the job done faster.

Reduce Inventory

This is the only wire connector you'll need. It is ideal for use on two-wire control systems.

- Use for standard controllers, valve boxes and soil moisture sensors.
- Wire combinations ranging from 22ga to 6ga.
- Use on connections from 24 VAC to 600 VAC.
- UL 486D certified for direct burial.

Avoid Call Backs

Locating and repairing a corroded wire splice costs time and money. Avoid unnecessary service, due to splicing. Use Rain Bird Wire Connectors for reliable connections.

- The strain relief ensures wires are secure and won't pull apart.
- Waterproof silicone sealant protects against corrosion.
- UV-resistant material ensures product performance does not degrade even after long periods of exposure to sunlight.



HOW TO SPECIFY

WC	-	XXX
WIRE CONNECTOR		PACK
WC		100

FEATURES AND BENEFITS

- Direct-bury silicone-filled tube with strain relief
- UL 486D listed and 600V rated waterproof and corrosion-proof
- Patented snap-fit lid provides strain relief
- UV- and impact-resistant
- Excellent for above-ground or direct-bury applications
- Pre-filled with silicone that never hardens
- Includes Red Nut Connector
- Wire Range: Red #6 – #22
- Perfect for Two-Wire Decoder Systems, Field Controllers or Integrated Control Systems (ICS)





St. Georges Golf and Country Club

Integrated Course Control

One Interface. Expansive Possibilities.

From the leader in golf course irrigation comes another game-changing innovation. With the Integrated Control Interface Plus (ICI+) and ICI+LINK from Rain Bird, you can bring the intelligent IC System™, Two-Wire Satellites and LINK™ (wireless) Satellites all onto the same interface. Rain Bird® ICI+ and ICI+LINK open up new and less disruptive ways to renovate or expand your course with the IC System.



Three Options in One Interface

Manage Rain Bird Two-Wire Satellites, LINK Satellites, IC System or any combination of all three from one interface.

An Easier Way to Upgrade

Extend the life of your current Rain Bird satellite system and get the latest in irrigation technology without a complete overhaul.

Unmatched Wireless Capabilities

Enjoy greater design flexibility without communication wires and license requirements with the ICI+LINK and LINK 900 MHz radios.

Integrated Course Control

With the ability to bring together Rain Bird's intelligent IC System™, Two-Wire Satellites and LINK™ (wireless) Satellites, the Rain Bird® ICI+ is the industry's first integrated interface. This revolutionary interface is ideal for phased-in renovations or expansions, offering a less disruptive and more economical way to add the IC System and IC Sensor Devices (IC CONNECT™) to an existing Rain Bird satellite system.

SPECIFICATIONS

ICI+ Electrical Specifications

- 115 VAC:** Nominal 98-132 VAC
- 220-240 VAC:** Nominal 208-255 VAC
- 100 VAC:** Nominal 91-110 VAC

Maximum Wire Paths

- Cirrus™:** 12 interfaces, 48 wire paths
- Nimbus™ II:** 8 interfaces, 32 wire paths
- Stratus™ II:** 2 interfaces, 8 wire paths¹
- StratusLT™:** 1 interface, 1 wire path

Wire Path Sizing: Follow the "Rain Bird IC System Design Guide" for wire path sizing

Satellite Compatibility: ICI+ and ICI+LINK compatible with Rain Bird MSC+, PAR+ and PAR+ES Satellite models²

IC/Satellite Integrated System:

- Multiple Interface:** Nimbus II or Cirrus, version 8.1.0 or higher, required if operating multiple interfaces
- Single Interface:** Stratus II, Nimbus II or Cirrus, version 8.1.0 or higher required if operating a single interface

Dimensions:

- ICI+ Interface:**
- Height:** 12.7 in (32.2 cm)
- Width:** 14.3 in (36.4 cm)
- Depth:** 5.8 in (2.3 cm)

Environment:

- Indoor Installation Only**
- Operating Temperature:** 14° F to 125° F (-10° C to 51° C)
- Storage Temperature:** -40° F to 150° F (-40° C to 65° C)
- Operating Humidity:** 75% max at 40° F to 108° F (4.4° C to 42° C)
- Storage Humidity:** 75% max at 40° F to 108° F (4.4° C to 42° C)

Output Voltage: 26-29 VAC



Integrated Control Interface Plus (ICI+)

Upgrade without a major overhaul with ICI+ and ICI+LINK. Make it affordable to expand or renovate your course—extending the life of your current system.

HOW TO SPECIFY — ICI+

ICI+	—	XXX
MODEL		POWER (Two-Wire Model Only)
ICI+ = Two-Wire		100=100 VAC
		120=120 VAC
		230=230 VAC
ICI+LINK = Wireless		

Model	A IC System Capacities		+	B Satellite Capacities		≤	C IC/Satellite Capacities*		D LINK Satellite Capacities**	
	Max Wire Groups	Max ICMs		Max Wire Groups	Max Stations		Max Wire Groups	Max Stations	Max Wire Groups	Max Stations
ICI+	4	3000		4	2688		4	3000	—	—
ICI+LINK	—	—		—	—		—	—	4	2688
ICI+LINK & ICI+ Driver Board	2	1500		2	1344		2	1500	4	2688

*In a system that includes both ICMs and Satellites, the total number of stations must not exceed those indicated by table C. ** Total Interface capacity equals Maximum Combined ICM and Satellite Stations plus LINK Satellite Stations (total of table C + table D).

1. Purchase of additional wire path key code required. 2. The IFX Satellite Board is standard in all Rain Bird PAR+ES Satellites manufactured after 12/22/19 and is compatible with all PAR+ES, PAR+ and MSC+ Satellites. To add the IC System to an ICI+LINK with LINK Satellite System, simply install an ICI+ Two-Driver Board (sold separately), connect the MAXI Cable to the interface, then add IC Rotors, IC Valves or IC CONNECT devices to the MAXI Cable.

Access the Latest Technology

Add IC Rotors, IC Valves and IC CONNECT onto your existing Rain Bird satellite system with the industry's only complete course solution. With IC CONNECT, you can manage integrated control sensor inputs to collect information from your course and turn non-irrigation products on and off.

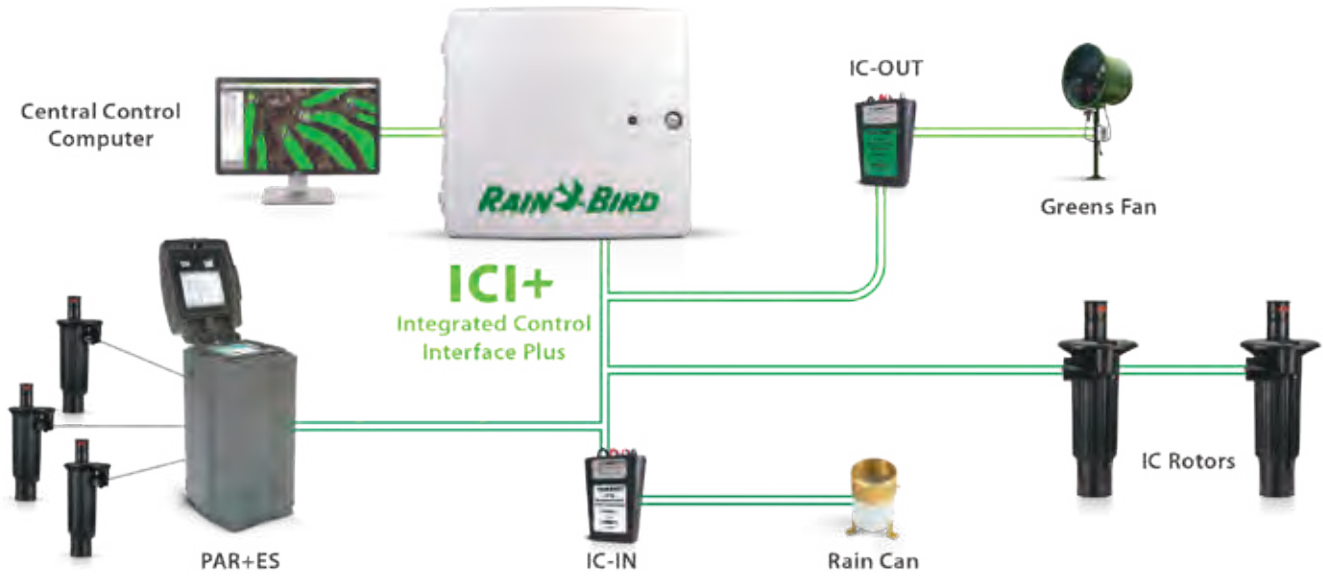

INTEGRATED COURSE CONTROL

IFX Satellite Board

By updating your existing Rain Bird® MSC+, PAR+ and PAR+ES Controllers with the IFX Satellite Board*, you now have the ability to add IC Rotors and Valves by simply tapping into the existing satellite MAXI™ Cable.



IFX
CONNECTED



**The IFX Satellite Board is standard in all new Rain Bird PAR+ES Satellites and is compatible with all MSC+, PAR+ and PAR+ES Satellites.*



Atlanta Athletic Club

Pump Stations and Filtration *System-Powering Performance and Efficiency.*

Rain Bird applies our world-leading irrigation expertise to the design and manufacture of golf pump stations and filters. As part of a fully integrated Rain Bird irrigation system, these pump stations bring real-time response to your pump, monitoring the operation of the pump and maximizing flow throughout the irrigation cycle. You'll get reduced water use, lower energy costs and less wear and tear on your pump station.

RAIN BIRD®



Designed for Durability

Rain Bird® pump stations and filters are built to the highest quality standards. Whether it's a sophisticated suppression system that reduces the risk of electronic component damage or a durable polyester powder coating that protects the appearance of your investment, these pumps and filters offer enduring performance.

A Fit for Any Environment or Budget

Every Rain Bird pump station is custom built for the specific requirements of your course, offering a variety of options that make it easier to achieve the most efficient performance possible.

HORIZONTAL PUMPS



	Pump Direction and Number	Motor (with VFD)	Max psi (bar)	Max gpm (lps) (m ³ /h)	Enclosure	Display
HES1	One horizontal end suction pump	15 to 60 HP	125 psi (8.6 bar)	600 gpm (37.8 lps, 136.3 m ³ /h)	Aluminum	Monochrome touch-panel Optional color touch-panel
HES2	Two horizontal end suction pumps	15 to 60 HP	125 psi (8.6 bar)	1200 gpm (76 lps, 273 m ³ /h)	Aluminum	Monochrome touch-panel Optional color touch-panel
HES3	Three horizontal end suction pumps	20 to 60 HP	125 psi (8.6 bar)	1800 gpm (114 lps, 409 m ³ /h)	Aluminum	Monochrome touch-panel Optional color touch-panel

VERTICAL PUMPS



	Pump Direction and Number	Motor (with VFD)	Max psi (bar)	Max gpm (lps) (m ³ /h)	Enclosure	Display
VM1	One vertical multistage pump	15 to 60 HP	155 psi (10.7 bar)	500 gpm (31.5 lps, 113.6 m ³ /h)	Aluminum	Monochrome touch-panel Optional color touch-panel
VM2	Two vertical multistage pumps	15 to 60 HP	150 psi (10.3 bar)	1000 gpm (63.1 lps, 227 m ³ /h)	Aluminum	Monochrome touch-panel Optional color touch-panel



PANEL ONLY

	Number of Pumps	Motor Type	Additional Accessories
Panel	Controls 1 to 10 pumps up to 100 HP each	VFD or VPM	Flow meter and pressure transducer included

Ask about our retrofit options for existing panels.

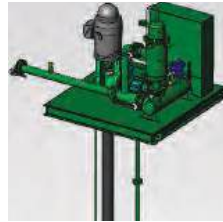

COMPACT DECKS

Features	VT1	VT2
Motor (with VFD)	15 to 75 HP	25 to 75 HP
Max psi (bar)	140 psi (9.7 bar)	140 psi (9.7 bar)
Max gpm (lps) (m ³ /h)	800 gpm (51 lps, 181 m ³ /h)	1600 gpm (101 lps, 363 m ³ /h)
Display	Color touch-panel	Color touch-panel



LARGE DECKS

Features	VT2	VT3	VT4
Integrated Filtration	Yes	Yes	Yes
Motor (with VFD)	20 to 100 HP	40 to 100 HP	40 to 100 HP
Max psi (bar)	140 psi (9.7 bar)	140 psi (9.7 bar)	140 psi (9.7 bar)
Max gpm (lps) (m ³ /h)	2000 gpm (126 lps, 454 m ³ /h)	3000 gpm (189 lps, 681 m ³ /h)	4000 gpm (252 lps, 908 m ³ /h)
Display	Color touch-panel	Color touch-panel	Color touch-panel

VT-Custom

- Custom-designed to meet your requirements.
- Provide us with your specifications.
- Five or more motors
- Multiple filter configurations

Remote Pump Station Access

Rain Bird's user interface is a network ready design that allows for remote access via PC, laptop, tablet, smartphone or any web-enabled mobile device. The screen always formats properly to the remote device and allows complete control and monitoring of the golf pump station. This remote accessibility provides Rain Bird customers the confidence to control their pumping systems when they are away from the course.

Electrical Design

Rain Bird pump stations are UL508A listed and use the industry's best surge suppression, reducing the risk of electronic component damage that could lead to inconvenient and costly downtime. This design includes full heavy-duty circuit breaker integration providing the ultimate protection with the best serviceability.

Backup Pressure Regulation

Every station comes with a properly sized pressure relief valve to provide automatic pressure regulation in the event of an overpressure situation.

VFD Per Motor (VPM) Option

Rain Bird offers the industry's most comprehensive catalog of customer-focused solutions, including a VFD for each main motor on a multi-pump station. This option provides superior flow and pressure regulation, and eliminates mechanical switching components, increasing uptime. It also provides a level of efficient backup pressure regulation that a pressure relief valve or butterfly valve cannot deliver.

Durable Polyester Powder-Coating

Rain Bird's in-house steel-grit blasting system assures all exterior surfaces of the pump station are prepared to white metal specification standards and allows for the best coating adhesion. The polyester powder-coat Rain Bird applies is far more durable than competitive solvent-based multi-layer coatings. In fact, Rain Bird's powder-coating process scores a 10 out of 10 on an ASTM corrosion test provided by Sherwin Williams. Other industry pump stations scored four (4) out of 10 on the very same test. In addition, the powder-coating process is considered very environmentally friendly.

Engineered Pump Station Skid Design

Using 3D modeling, the channel steel skid frame is engineered for strength and rigidity. This engineered design reduces vibration and eliminates the need for raised, extra-thick steel plates under the pump heads, which can be a trip hazard. The deck is the industry's strongest and longest lasting with continuously welded smooth steel plate. In addition, Rain Bird follows industry standards and manufacturers' recommendations for station components such as the proper specifications for flow meters.

Advanced Controls

With the industry's leading touch screens, Rain Bird continues to innovate by offering sizes up to 15". Beyond being network ready, this interface offers up to 20 years of historical memory capability and USB backup. With features such as filtration integration, water feature control, lake level control, pump lockouts, auto set point adjustment per pump, motor starts protection, and many more, Rain Bird has driven pump station innovation in the golf industry for the last decade.

Real-Time System Integration

Rain Bird pump stations have Pump Manager 2 and Smart Pump™ technology at the central control, so you can configure your system to automatically monitor and self-adjust to changing conditions. This seamless integration by Rain Bird improves your system's overall performance by reducing watering windows and minimizing energy use.

Pump and Motor Options

Rain Bird offers custom designed cast ductile iron discharge heads for golf irrigation pump stations. With superior flow characteristics and 12 times the required tensile strength for golf pump stations, they are the obvious choice for the application. Rain Bird utilizes G.E. motors with industry-leading warranties, efficiencies and durability. The standard Class H motor insulation provides unmatched motor life.

Air Relief

Rain Bird provides air relief on each pump. Individual air relief valves allow for the maximum amount of air to be removed from the pump columns and not enter into the irrigation system.

User Controls

Rain Bird pump stations have set the bar with simple, large-icon touchscreen controls in nine (9) different languages. Each pump has a lighted, three position Manual-Off-Auto switch for intuitive, safe backup control of the station.



Custom colors available.

Pump Manager 2

Rain Bird® Pump Manager 2 is engineered for the golf course professional looking to simplify pump control, monitoring and data reporting. This powerful software application gives you full control of your pump station from your computer or central control.

FEATURES AND BENEFITS

- Provides a direct link to the pump station touchscreen so you can view and modify pump operations from your computer or tablet as though you were standing right in front of it.
- Since all pump operation data is contained on your computer, Pump Manager 2 and its built-in reporting capabilities can keep you apprised of operations, flow, water use and other key information.
- Includes common reports for future review or regulatory reporting.
- For customized reporting, data can be exported in a file compatible with common spreadsheet applications such as Microsoft® Excel®.
- Standard with 11 different language options.
- Can be used with any computer and provide remote monitoring for any irrigation system using a competitive control system.
- Best of all, Pump Manager 2 is fully integrated with Rain Bird's exclusive central control feature, Smart Pump.



Smart Pump™

FEATURES AND BENEFITS

Rain Bird's Smart Pump is a powerful central control software tool that improves pump station performance more than any comparable product on the market. It integrates your irrigation system from reservoir to rotor, constantly comparing actual flow to expected flow. By making smart, real-time decisions based on this information, it optimizes your system — saving water, conserving electricity and reducing wear and tear on your valuable pumping system.

Actual Flow Measurement

Unlike other irrigation central control software, Smart Pump bases its decisions on actual flow, not estimated flow. By using accurate information — in real time — Smart Pump automatically balances supply with system demand. That means greater efficiency and an end to wasted water and electricity.

24-Hour Pump Supervision

With Smart Pump, you can relax knowing your system will instantly respond to actual field conditions with the right decisions. For instance, if a pipe breaks, Smart Pump will stop water flow to the pipe to prevent turf damage. Or if a pump fails, Smart Pump will make immediate water demand adjustments to keep the system from shutting down permanently. It's like having your own irrigation supervisor at every sprinkler, 24/7.

Integration Meets Intelligence

Smart Pump seamlessly integrates your entire irrigation system. It automatically starts waiting sprinklers or pauses active sprinklers to reduce flow or increase demand, keeping your irrigation system running at peak efficiency at all times.

Rain Bird is the only manufacturer providing both irrigation and pump station control software. This provides a level of integration that is unmatched in the industry.

HOW TO SPECIFY

SMARTPUMPM
MODEL
Smart Pump

Self-Cleaning Pump Suction Screen

Keep debris out of your pumping and irrigation system.

FEATURES

- Galvanized, self-cleaning pump suction screen removes large trash and debris from water sources, saving time and money in energy, pumping efficiency and maintenance costs.
- Heavy 12 or 24 mesh stainless steel screen increases your pump efficiency for many years to come.
- All water must pass through the pump suction screen attached to the end of the pump suction line before entering the pump intake pipe. A small, side-stream from the pump discharge plumbing drives two spray bars that continually rotate, jetting water at the screen and blasting debris away.



Performance Data

Model Number	Flow		Screen Length (in)	Total Length (in)	Screen Diameter (in)	Flange Size (in)	Return Inlet Pipe Size (in)	Operating Pressure (min-max psi)	Weight (lbs)	Cleaning Spray (gpm)
	(gpm)	(m ³ /h)								
PSS200	325	73.8	11	25	16	4	1.5	35-100	38	20
PSS400	550	124.9	15	28.8	16	6	1.5	40-100	57	20
PSS600	750	170.3	16	32.5	24	8	1.5	40-100	101	20
PSS800	950	215.7	18	34.5	24	10	1.5	45-100	108	20
PSS1000	1350	306.5	23	39.5	24	10	1.5	50-100	116	24
PSS1400	1650	374.6	26	42.5	24	12	1.5	55-100	128	24
PSS1700	1950	442.7	28	44.5	26	12	1.5	55-100	148	24
PSS2000	2350	533.5	32	48.5	26	14	1.5	60-100	160	24
PSS2400	2600	590.2	35	52.5	30	16	1.5	65-100	233	28
PSS3000	3000	681.0	40	57.5	30	16	1.5	40-65	236	44
PSS3500	3500	794.5	40	59.5	36	18	1.5	40-65	283	44
PSS4000	4000	908.0	40	63.5	42	18	1.5	40-65	358	44

Performance data based on 12-mesh filter.

Additional Filtration Products

Rain Bird offers an extensive line of filtration products to fit any course need. For more information about these products, contact Rain Bird Filter Department at filters@rainbird.com or 520-741-6189.



HDF 2 Disc Filters

Automatic self-cleaning disc filtration equipment with 2" valves and high-density polyethylene manifold.



HN-G-02-1



HN-G-02-2

Low Flow Rate Secondary Screen Filters

G-Series HN Filters for secondary low-flow zones requiring finer filtration. Typically 40-70 gpm but dependent on micron size required (multiple filters can also run in parallel for higher flows). Available with controller (-1 model) or without controller (-2 model). Special setup required for use without controller, inquire with factory.

I-Series Hydraulic Suction Scanning Filter

Self-cleaning line powered hydraulic water filters for turf, landscape, agriculture, greenhouse, golf course and nursery applications.



FEATURES

- **Flow Rate:** 600 to 3,400 gpm (136.27 to 772.22 m³/h)
- **Max Temperature:** 160° F (71° C)
- **Flushing Operations:** Single electric ball valve for flushing operations standard
- **Screen:** Stainless steel mesh/PVC and stainless steel sintered screen options
- **Screen Opening:** 5µ to 4000µ
- **Working Pressure:** 40 to 150 psi (2.76 to 10.34 bar)
- **Material:** Powder-coated carbon steel, stainless steel and duplex stainless options
- **Configurations Available:** Filter only, or a complete assembly with bypass manifold and valves

Standard Bypass Manifold

Line Size	Model Number Powder Coated Carbon Steel	Max Flow Rate (gpm)
3"	I-3-CS-F	300
4"	I-4-CS-F	600
6"	I-6-CS-F	800
8"	I-8-CS-F	1500
10"	I-10-CS-F	3200
12"	I-12-CS-F	3400

Performance Data

Line Size	Model Number	Woven Screen Area (in ²)	Sintered Screen Area (in ²)	Max Flow Rate (gpm)	Std. Flow Rate (gpm)	Std. Flow Rate (gpm)	Std. Flow Rate (gpm)	Flush Volume (gpm)	Rinse Duration (seconds)	Flush Line Size (in)	300	200	120	100	Micron
											50	75	125	140	Mesh
Powder Coated Carbon Steel															
3"	HO-I-03-PS-C	254	—	300	300	300	260	≈ 35	16 to 18	1.5"					
4"	HO-I-04-PS-C	413	—	500	500	500	420	≈ 35	16 to 18	1.5"					
6"	HO-I-06-PS-C	413	—	750	750	580	420	≈ 35	16 to 18	1.5"					
8"	HO-I-08-PM-C	413	—	1000	830	580	420	≈ 35	16 to 18	1.5"					
8"	HO-I-08-PS-C	614	—	1400	1240	880	650	≈ 65	16 to 18	2"					
10"	HO-I-10-PS-C	614	—	2000	1300	920	675	≈ 65	16 to 18	2"					
12"	HO-I-12-PS-C	826	—	2750	1800	1200	850	≈ 65	16 to 18	2"					
14"	HO-I-14-PS-C	826	—	3750	1950	1300	875	≈ 65	16 to 18	2"					
Stainless Steel															
3"	HT-I-03-LP-S	—	360	300	300	300	300	≈ 12	10 to 12	1"					
4"	HT-I-04-PE-S	—	720	600	600	600	600	≈ 35	10 to 12	1.5"					
6"	HT-I-06-PE-S	—	720	800	800	800	720	≈ 35	10 to 12	1.5"					
8"	HT-I-08-PS-S	—	1,008	1,400	1,400	1,400	1000	≈ 35	10 to 12	1.5"					
8"	HT-I-08-PE-S	—	1,152	1,500	1,500	1,500	1152	≈ 65	10 to 12	2"					
10"	HT-I-10-PE-S	—	1800	3,200	3200	2520	1800	≈ 65	10 to 12	2"					
12"	HT-I-12-PS-S	—	1820	3,400	3,400	2550	1850	≈ 65	10 to 12	2"					

Standard flow rates assume average water quality (<40 ppm solids).

All models must have an inlet pressure during rinse cycle of at least 40 psi.

Models and performance data listed are a sample representation of the product line as applied with average water quality. Specific model and performance data can be supplied upon quote request and is based on water source, water quality and filtration level (micron size) required.

Standard drawings are available at www.rainbird.com. Quotations are available upon request at filters@rainbird.com or rainbird.com/golf/products/filtration

Standard Rain Bird controller: 110V AC

E-Series Electric Suction Scanning Filter

Rain Bird's E-Series automatic self-cleaning water filters utilize an electric motor to assist in cleaning during the backwash cycle in turf, landscape, agriculture, greenhouse, golf course, nursery applications and emerging green and blue industries like Aquaculture. Rain Bird electric filters can operate at system pressures as low as 15 psi.

FEATURES

- **Flange:** Parallel
- **Flow Rate:** 400 to 4,250 gpm (90.85 to 965.28 m³/h)
- **Max Temperature:** 210° F (99° C)
- Single electric ball valve for flushing operations standard
- 316 L stainless steel sintered screens standard
- **Screen Opening:** 5µ to 4000µ
- **Working Pressure:** 15 to 150 psi (1.03 to 10.34 bar)
- **Materials of Construction:** Powder-Coated Carbon Steel, Stainless Steel and Duplex Stainless Steel Options
- Available as a filter unit only, or as a filter assembly including bypass plumbing and valves



Stainless steel



Powder-coated carbon steel

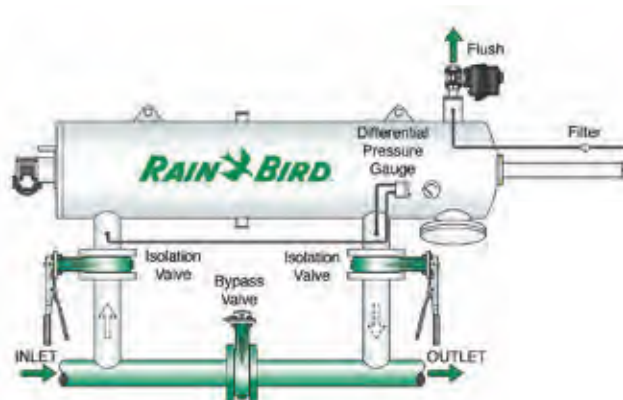

Performance Data

Line Size	Model Number	Sintered Screen Area (in ²)	Max Flow Rate (gpm)	Std. Flow Rate (gpm)	Micron Mesh	
					300	200
4"	E-04-PS-G	620	400	360	≈ 50	2"
6"	E-06-PE-G	930	720	650	≈ 50	2"
8"	E-08-PS-G	930	1320	1200	≈ 50	2"
10"	E-10-PE-G	1240	1800	1620	≈ 100	2"
12"	E-12-PS-G	1240	2650	2385	≈ 100	2"
14"	E-14-PE-G	1560	4250	3825	≈ 100	2"

Standard Bypass Manifold

Line Size	Model Number	Max Flow Rate
4"	E-4-CS-F	600 gpm
6"	E-6-CS-F	800 gpm
8"	E-8-CS-F	1500 gpm
10"	E-10-CS-F	3200 gpm
12"	E-12-CS-F	3400 gpm
12"	E-12-CS-F	3400 gpm

Standard flow rates assume average water quality (<40 ppm solids).

E-Series models are specifically designed for pressures < 40 PSI.

Models and performance data listed are a sample representation of the product line as applied with average water quality. Specific model and performance data can be supplied upon quote request and is based on water source, water quality and filtration level (micron size) required.

Quotations are available upon request at filters@rainbird.com or www.rainbird.com/golf/products/filtration

G-Series Hydraulic Suction Scanning Filter

The G-Series is a self-cleaning hydraulic suction scanning screen filter that is powered by source line water pressure. They provide worry-free medium-flow rate filtration for irrigation, industrial and municipal water sources.

G-Series self-cleaning water filters have a compact right angle flange configuration (90°). The G-Series automatic water filter is much smaller than its I-Series counterpart and provides a space-saving alternative.



FEATURES

- **Standard Flow Rates:** 200 to 1,320 gpm (45.42 to 300 m³/h)
- **Flush Cycle Duration:** 4 to 16 seconds
- **Flush Valve Size:** Single 1" or 1.5"
- **Screen:** Stainless steel mesh/PVC and stainless steel sintered screen options
- **Screen Opening:** 5µ to 4000µ
- **Maximum Temperature:** 210°F (99° C)
- **Flush Volume:** 3 to 7 gallons per backwash
- **Working Pressure:** 35 to 150 psi (2.40 to 10.34 bar)
- **Material of Construction:** Powder-coated carbon steel, stainless steel and duplex stainless options
- Available as filter only, or as a complete assembly with bypass manifold and valves

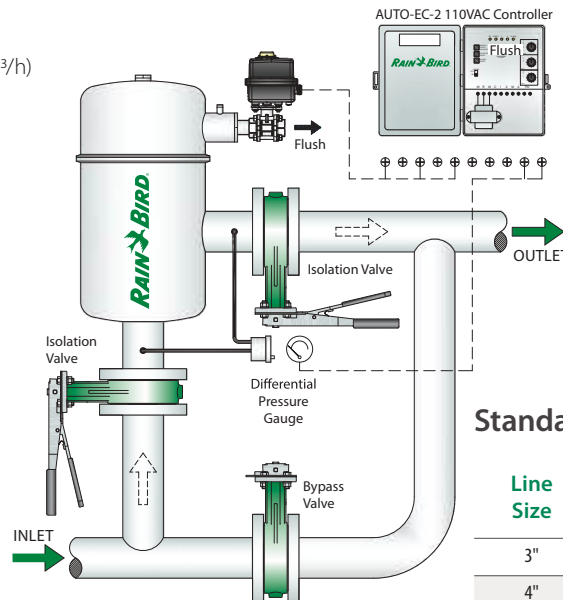

Standard Bypass Manifold

Line Size	Model Number	Max Flow Rate
3"	G-3-CS-F	200
4"	G-4-CS-F	600
6"	G-6-CS-F	750
8"	G-8-CS-F	1320

Performance Data

Line Size	Model Number	Woven Screen Area (in ²)	Sintered Screen Area (in ²)	Max Flow Rate (gpm)	Std. Flow Rate (gpm)	Std. Flow Rate (gpm)	Std. Flow Rate (gpm)	Flush Volume (gpm)	Rinse Duration (seconds)	Flush Line Size (in)	300	200	120	100	Micron
											50	75	125	140	Mesh
Powder Coated Carbon Steel															
3"	HO-G-03-LE-C	120	—	200	200	170	120	≈ 10	8 to 10	1"					
4"	HO-G-04-LS-C	120	—	300	250	170	120	≈ 10	8 to 10	1"					
4"	HO-G-04-LE-C	466	—	500	500	500	470	≈ 25	8 to 10	1.5"					
6"	HO-G-06-LS-C	466	—	750	750	650	460	≈ 25	8 to 10	1.5"					
8"	HO-G-08-LS-C	648	—	1300	1300	905	650	≈ 25	8 to 10	1.5"					
8"	HO-G-08-LE-C	810	—	1320	1320	1135	810	≈ 55	8 to 10	2"					
Stainless Steel															
3"	HT-G-03-LE-S	—	216	200	200	200	200	≈ 10	8 to 10	1"					
4"	HT-G-04-LS-S	—	432	500	500	500	430	≈ 10	8 to 10	1"					
4"	HT-G-04-LE-S	—	720	600	600	600	600	≈ 10	8 to 10	1"					

Standard flow rates assume average water quality (<40 ppm solids) and some type of pre-filter for large solids (pump suction screen / wye-strainer) if water source is a lake or river. All models must have an inlet pressure during rinse cycle of at least 35 psi. Models and performance data listed are a sample representation of the product line as applied with average water quality. Specific model and performance data can be supplied upon quote request and is based on water source, water quality and filtration level (micron size) required. Standard drawings are available at www.rainbird.com. Quotations are available upon request at filters@rainbird.com or www.rainbird.com/golf/products/filtration

Standard Rain Bird controller: 110V AC (G-Series filters integrated with a Rain Bird pump station are controlled by the pump station PLC/controllers).



Chiricahua at Desert Mountain

Valves and Valve Boxes

Raising the Standards of Reliability.

Rain Bird valves are expertly engineered and manufactured to provide a level of quality and durability that's unmatched in the industry. Constructed of industrial-strength glass-filled nylon or classic brass, every model is built to stand up to the harshest environments. For decades, these valves have been delivering trouble-free performance that continues to earn the trust of golf course maintenance professionals worldwide.



Options for Every Need

Hold every aspect of your system to the highest standard. From pre-assembled, reclaimed water applications to an integration control (IC) configuration, Rain Bird valves are designed to meet the needs of any course.

GSV Series Valves



Rain Bird® GSV Series Valves deliver reliable performance you can trust year after year in a full line of plastic and brass options. With precision pressure regulation pre-installed, the GSV Series provides an innovative solution that's strong enough to weather any storm.

FEATURES AND BENEFITS

Powerful Surge Resistance

Withstand surge events up to 25kV with the GBS25 Solenoid, or up to 20kV with ICM.

Adjustable Pressure Regulation

Pre-installed PRS-DIAL regulates and maintains constant outlet pressure between 15 and 100 psi (1.04 to 6.90 bar) within ±3 psi (±0.21 bar).

- When inlet pressure exceeds 100 psi (6.90 bar), a pressure-regulating master valve or inline pressure regulator is recommended
- Improved pressure spike reduction capabilities minimize water hammer
- Waterproof dial cartridge eliminates fogging and binding
- Consistent sprinkler performance for block applications
- Ergonomic design with snap-tight cover on dial cartridge prevents vandalism

Engineered for Reclaimed Water

Chlorine-resistant diaphragm delivers increased protection against harsh chemicals. Optional purple flow control handle and cover allow for easy indication of non-potable water use.

Uncompromising Durability

Plastic models feature a glass-filled polypropylene body that delivers heavy-duty performance up to 200 psi (13.80 bar) pressure.

- GSV211 (BSP only) model includes a red brass body and bonnet for longer life and more rugged performance up to 200 psi (13.80 bar) pressure
- Scrubber mechanism (plastic models only) encapsulates stainless steel screen to dislodge grit and plant material
- External bleed protects solenoid ports from debris when system is flushed

SPECIFICATIONS

Models:

- GSV100 / GSVIC100:** Plastic 1" (2.5 cm) (26/34), NPT
- GSV101 / GSVIC101:** Plastic 1" (2.5 cm) (26/34), BSP
- GSV150 / GSVIC150:** Plastic 1.5" (3.8 cm) (40/49), NPT
- GSV151 / GSVIC151:** Plastic 1.5" (3.8 cm) (40/49), BSP
- GSV200 / GSVIC200:** Plastic 2" (5.1 cm) (50/60), NPT
- GSV201 / GSVIC201:** Plastic 2" (5.1 cm) (50/60), BSP
- GSV211 / GSVIC211:** Brass 2" (5.1 cm) (50/60), BSP

Flow:

5 to 200 gpm (19.2 to 757 l/m); (1.1 to 45.4 m³/h)

Pressure:

Up to 200 psi (13.80 bar)*

Electrical Specifications:

GBS25 Solenoid:

Power: 24 VAC 50/60 Hz (cycles/second)

Inrush Current: 0.41 A (9.84 VA)

Holding Current: 0.20 A (4.80 VA) at 60 Hz, 0.23 A (5.40 VA) at 50 Hz

ICM:

Electrical Output: 28.5 VAC, 1.25 AMP Per Wire Path

HOW TO SPECIFY

MODEL	SIZE
GSV	100 = 1" NPT
GSV	101 = 1" BSP
GSVIC	150 = 1 1/2" NPT
	151 = 1 1/2" BSP
	200 = 2" NPT
	201 = 2" BSP
	211 = 2" BSP (brass)



Purple flow control handle and cover included to designate non-potable water.



*While the PRS-Dial unit can withstand pressures up to 200 psi (13.80 bar), accurate pressure regulation can be maintained only up to 100 psi (6.90 bar).

DIMENSIONS

MODEL	SIZE	HEIGHT	LENGTH	WIDTH
GSV100 / GSV101 / GSVIC100 / GSVIC101	1"	8.3" (21.1 cm)	5.6" (14.2 cm)	5.2" (13.2 cm)
GSV150 / GSVIC150 / GSV151 / GSVIC151	1.5"	9.5" (24.1 cm)	6.1" (15.5 cm)	6.2" (15.8 cm)
GSV200 / GSV201 / GSVIC200 / GSVIC201	2"	9.9" (25.2 cm)	6.1" (15.5 cm)	6.2" (15.8 cm)
GSV211 (Brass) / GSVIC211 (Brass)	2"	9.4" (23.9 cm)	6.9" (17.5 cm)	5.9" (14.9 cm)

U.S. Data — Pressure Loss (psi)

Flow gpm	GSV100 GSV101 GSVIC100 GSVIC101	GSV150 GSV151 GSVIC150 GSVIC151	GSV200 GSV201 GSVIC200 GSVIC201	Flow gpm	GSV211 GSVIC211
	1"	1½"	2"		2"
5	2.9	—	—	5	—
10	2.9	—	—	10	—
15	—	—	—	15	—
20	2.6	3.5	—	20	0.5
30	5.8	3.1	—	30	0.6
40	10.2	2.3	—	40	0.8
50	16.0	2.1	—	50	1.1
60	—	—	—	60	1.8
75	—	4.3	3.3	80	2.4
100	—	7.5	4.7	100	3.8
125	—	11.9	8.6	120	5.9
150	—	17.0	12.6	140	7.8
175	—	—	14.8	160	10.0
200	—	—	18.9	180	12.5
				200	15.8

Rain Bird recommends flow rates in the supply line not to exceed 7½ ft/sec (2.29 m/s) to reduce the effects of water hammer.

Metric Data — Pressure Loss (bar)

Flow l/m	m³/h	GSV100 GSV101 GSVIC100 GSVIC101	GSV150 GSV151 GSVIC150 GSVIC151	GSV200 GSV201 GSVIC200 GSVIC201	Flow l/m	m³/h	GSV211 GSVIC211
		1"	1.5"	2"			2"
20	1.2	0.20	—	—	19	1	—
50	3	0.19	—	—	50	3	—
100	6	0.32	0.22	—	100	6	0.04
150	9	0.69	0.16	—	150	9	0.05
200	12	—	0.16	—	200	12	0.09
250	15	—	0.24	—	250	15	0.14
300	18	—	0.33	0.25	300	18	0.16
350	21	—	0.45	0.30	350	21	0.23
400	24	—	0.59	0.38	400	24	0.30
450	27	—	0.75	0.53	450	27	0.40
500	30	—	0.91	0.67	500	30	0.49
550	33	—	1.10	0.82	550	33	0.58
600	36	—	—	0.92	600	36	0.68
650	39	—	—	1.00	650	39	0.79
700	42	—	—	1.13	700	42	0.92
757	45	—	—	1.30	757	45	1.09

INTEGRATED CONTROL SYSTEM TECHNOLOGY

See the features and benefits of IC Rotors and Valves on page 26.



PRS-DIAL

Maintain the constant pressure you need between 15 and 100 psi (1.04 to 6.90 bar), regardless of incoming pressure fluctuations with the PRS-DIAL. The regulator fits all Rain Bird PGA, PEB, PESIC, and GB Series Valves.

(See pages 56–57)



PRS-Dial

The PRS-Dial is an excellent means of regulating outlet pressure at the valve regardless of incoming pressure fluctuations. The visible scale makes adjustment quick and easy. The regulator fits all Rain Bird® PGA, PEB, PESB, PESB-R, GB, EFB-CP and BPES series valves.

- Regulates and maintains constant outlet pressure between 15 and 100 psi (1.04 to 6.9 bar) within ± 3 psi (± 0.21 bar).
- Adjustment knob with detents permits fine-tune setting in $\frac{1}{3}$ psi (0.02 bar) increments. Dial cartridge makes installation and adjustment quick, easy and accurate.

FEATURES

- Improved spike reduction capabilities reduce water hammer.
- Ergonomic design with snap-tight cover to prevent vandalism.
- Waterproof dial cartridge eliminates fogging and binding.
- Dial cartridge retrofits into all existing PRS-D units.
- Schrader valve connects pressure hose gauge, ordered separately.
- Easy field installation — PRS-Dial threads underneath the solenoid and adapter.
- Corrosion-resistant glass-filled nylon for rugged performance.

SPECIFICATIONS

Operating Range:

Pressure: Up to 100 psi (6.9 bar)*

Regulation: 15 to 100 psi (1.04 to 6.9 bar)

Flow: Refer to chart

Model: PRS-D

APPLICATION INFORMATION

- Proper operation requires inlet pressure to be a minimum of 15 psi (1.04 bar) higher than desired outlet pressure.
- For areas with very high pressure or uneven terrain, install sprinklers with PRS pressure regulating stems and/or SAM check valves.
- When inlet pressure exceeds 100 psi (6.9 bar), a pressure regulating master valve or inline pressure regulator is recommended.
- Rain Bird does not recommend using the pressure regulating module for applications outside the recommended flow ranges.
- To reduce the effects of water hammer, Rain Bird recommends flow rates in the supply line not to exceed $7\frac{1}{2}$ ft/sec (2.29 m/s).
- For flows below 10 gpm (37.8 l/m, 2.27 m³/h), Rain Bird recommends the flow control stem be turned down two full turns from the fully open position.
- The PRS-D option adds an additional 2" (5.1 cm) to valve height.

*While the PRS-Dial unit can withstand pressures up to 200 psi (13.8 bar), accurate pressure regulation can be maintained only up to 100 psi (6.9 bar).

NOTE: Valve and PRS-D module must be ordered separately.



U.S. Data — Valve Flow Ranges **

Model	gpm
PGA	
100-PGA	5 – 40
150-PGA	30 – 100
200-PGA	40 – 150
PEB	
100-PEB	5 – 50
150-PEB	20 – 150
200-PEB	75 – 200
PESB / PESB-R	
100-PESB/PESB-R	5 – 50
150-PESB/PESB-R	20 – 150
200-PESB/PESB-R	75 – 200
GB	
100-GB	5 – 50
125-GB	20 – 80
150-GB	20 – 120
200-GB	20 – 200
EFB-CP-R	
100-EFB-CP-R	5 – 50
125-EFB-CP-R	20 – 80
150-EFB-CP-R	20 – 120
200-EFB-CP-R	20 – 200
BPES	
300-BPES	60 – 300

**The PRS-Dial regulates only up to 100 psi (6.9 bar).

Metric Data — Valve Flow Ranges **

Model	l/m	m ³ /h
PGA		
100-PGA	19.2 – 15.1	1.14 – 9.08
150-PGA	113 – 378	6.81 – 22.70
200-PGA	151 – 568	9.08 – 34.05
PEB		
100-PEB	19.2 – 189	1.14 – 11.35
150-PEB	76 – 568	4.54 – 34.05
200-PEB	284 – 757	17.03 – 45.40
PESB / PESB-R		
100-PESB/PESB-R	19.2 – 189	1.14 – 11.35
150-PESB/PESB-R	76 – 568	4.54 – 34.05
200-PESB/PESB-R	284 – 757	17.03 – 45.40
GB		
100-GB	19.2 – 189	1.14 – 11.35
125-GB	76 – 302	4.54 – 18.16
150-GB	76 – 529	4.54 – 31.78
200-GB	76 – 757	4.54 – 45.40
EFB-CP-R		
100-EFB-CP-R	19.2 – 189	1.14 – 11.35
125-EFB-CP-R	76 – 302	4.54 – 18.16
150-EFB-CP-R	76 – 529	4.54 – 31.78
200-EFB-CP-R	76 – 757	4.54 – 45.40
BPES		
300-BPES	227 – 1136	13.62 – 68.10

ICM Valve Kit

Rain Bird® ICM Valve Kit includes a ready-to-install ICM (Integrated Control Module) and a Rain Bird Valve Adapter with necessary o-rings and filter. This kit is designed to convert Rain Bird PEB, PESB, BPES, EFB-CP Series Electric Remote Control Valves into Integrated Control (IC) Valves.

See pages 24-29 for more information on the IC System™.



PESB with ICM Valve Kit

VB Series Valve Boxes



FEATURES

- Commercial-grade boxes.
- Multiple sizes and shapes designed with corrugated sides and wide flange bases for maximum durability, compression strength and stability.
- Smart lid design with no holes to keep out pests and beveled edges to minimize damage potential from turf equipment with an easy-access shovel slot for lid removal.
- Interlocking stacking capabilities, extension models and pipe hole knockouts support deeper and more flexible installations.
- All black bodies and lids are made from 100% recycled materials, making them earth-friendly and LEED compliant.
- Locking systems with vandal-resistant hex or penta bolt, washers and clips.
- **Warranty:** 5-year trade warranty

Locking Systems:

- VB-LOCK-H:** Hex Head $\frac{3}{8}$ " x $2\frac{1}{4}$ " (1.0 x 5.7 cm) bolt, washer and clip
- VB-LOCK-P:** Penta Head $\frac{3}{8}$ " x $2\frac{1}{4}$ " (1.0 x 5.7 cm) bolt, washer and clip

MODELS

Item ID	Lid Color	Model #
7" ROUND		
G11480	Green	GVB7RNDGR
G11481	Black	GVB7RNDBLK
G11482	Purple	GVB7RNDPUR
G11483	Tan	GVB7RNDTAN
10" ROUND		
G11450	Green	GVB10RNDGR
G11451	Black	GVB10RNDBL
G11452	Purple	GVB10RNDPU
G11453	Tan	GVB10RNDTA
STANDARD		
G11400	Green	GVBSTDGR
G11401	Black	GVBSTDBLK
G11402	Purple	GVBSTDPURP
G11403	Tan	GVBSTDTAN
JUMBO		
G11430	Green	GVBJMBGR
G11431	Black	GVBJMBBLK
G11432	Purple	GVBJMBPURP
G11433	Tan	GVBJMBTAN



Size	7" Round	10" Round	Standard	Jumbo
Bottom Diameter	9.9" (25.1 cm)	13.7" (34.9 cm)	—	—
Length x Width	—	—	21.8" (55.4 cm) x 16.6" (42.2 cm)	26.3" (66.8 cm) x 19.8" (50.3 cm)
Height	9.0" (22.9 cm)	10.0" (25.4 cm)	12.0" (30.5 cm)	12.1" (30.7 cm)
Number of Knockouts	4	4	13	2
Pipe Sizing	Knock-outs sized with 2" (50 mm) pipe	Knock-outs sized with 2" (50 mm) pipe	2 knock-outs sized for 3" (80 mm) pipe 11 knock-outs sized for 2" (50 mm) pipe	Knock-outs sized with 3" (80 mm) pipe

Quick Coupling Valves and Valve Keys

SPECIFICATIONS

Models:

- 3RC:** ¾" (1.9 cm) (20/27) Rubber cover, one-piece body
- 33DRC:** ¾" (1.9 cm) (20/27) Double track key lug, rubber cover, two-piece body
- 33DLRC:** ¾" (1.9 cm) (20/27) Double track key lug, locking rubber cover, two-piece body
- 33DNP:** ¾" (1.9 cm) (20/27) Non-potable, purple locking rubber cover, two-piece body
- 44RC:** 1" (2.5 cm) (26/34) Rubber cover, two-piece body
- 44LRC:** 1" (2.5 cm) (26/34) Locking rubber cover, two-piece body
- 44NP:** 1" (2.5 cm) (26/34) Non-potable, purple locking rubber cover, two-piece body
- 5RC:** 1" (2.5 cm) (26/34) Rubber cover, one-piece body
- 5LRC:** 1" (2.5 cm) (26/34) Locking rubber cover, one-piece body
- 5NP:** 1" (2.5 cm) (26/34) Non-potable, purple locking rubber cover, one-piece body
- 7:** 1 ½" (3.8 cm) (40/49) Metal cover, one-piece body

Flow:

- Models 3RC, 33DRC, 33DLRC, 33DNP, 44RC, 44LRC, 44NP, 5RC, 5LRC, 5NP, 7:** 10 to 125 gpm (37.8 to 473 l/m; 2.27 to 28.39 m³/h)
- Models 33DNP, 44NP, 5NP:** 10 to 70 gpm (37.8 to 265 l/m; 2.27 to 15.89 m³/h)

Pressure: 5 to 125 psi (0.4 to 8.6 bar)

Height:

- 3RC:** 4.3" (10.8 cm)
- 33DRC:** 4.4" (11.1 cm)
- 33DLRC:** 4.6" (11.8 cm)
- 33DNP:** 4.4" (11.1 cm)
- 44RC:** 6.0" (15.2 cm)
- 44LRC:** 6.0" (15.2 cm)
- 44NP:** 6.0" (15.2 cm)
- 5RC:** 5.5" (14.0 cm)
- 5LRC:** 5.5" (14.0 cm)
- 5NP:** 5.5" (14.0 cm)
- 7:** 5.8" (14.6 cm)



Quick Coupling Valve Keys

Top Pipe Threads					
Valve	Key	Male		Female	
3RC	33DK	¾"	19 mm	½"	13 mm
33DRC	33DK	¾"	19 mm	½"	13 mm
33NP	33DK	¾"	19 mm	½"	13 mm
44NP	44K	1"	25 mm	¾"	19 mm
44RC	44K	1"	25 mm	¾"	19 mm
5RC	55K-1	1"	25 mm	—	—
5NP	55K-1	1"	25 mm	—	—
7	7K	1 ½"	38 mm	—	—



Quick Coupling Valves

U.S. Data — Pressure Loss* (psi)						
Flow gpm	3RC ¾"	33DRC, 33DLRC, 33DNP ¾"	44RC, 44LRC, 44NP 1"	5RC, 5LRC, 5NP 1"	7 1 ½"	
10	1.8	2.0	—	—	—	
15	4.7	4.3	2.2	—	—	
20	7.2	7.6	4.4	—	—	
30	—	—	11.5	4.1	—	
40	—	—	—	7.3	—	
50	—	—	—	11.0	1.7	
60	—	—	—	15.7	2.5	
70	—	—	—	21.5	3.6	
80	—	—	—	—	4.9	
90	—	—	—	—	8.4	
100	—	—	—	—	14.0	

Metric Data — Pressure Loss* (bar)							
Flow		3RC 1.9 cm	33DRC, 33DLRC, 33DNP 1.9 cm	44RC, 44LRC, 44NP 2.5 cm	5RC, 5LRC, 5NP 2.5 cm	7 3.8 cm	
38	2.3	0.12	0.12	—	—	—	
67	4	0.41	0.42	0.23	—	—	
83	5	0.57	0.62	0.40	—	—	
100	6	—	—	0.62	—	—	
117	7	—	—	0.83	0.30	—	
133	8	—	—	—	0.40	—	
150	9	—	—	—	0.50	—	
167	10	—	—	—	0.61	—	
200	12	—	—	—	0.85	0.13	
233	14	—	—	—	1.15	0.18	
267	16	—	—	—	1.50	0.25	
367	22	—	—	—	—	0.54	
473	28	—	—	—	—	0.97	

VALVES AND VALVE BOXES

*The PRS-D option adds 2" (5.1 cm) to valve height. **Loss values are with flow control fully open using the tan solenoid retainer.



Old Marsh Golf Club

Landscape Solutions

Specialized Solutions for Every Application.

Rain Bird offers many landscape irrigation solutions that manage water responsibly while promoting the growth of healthy, stress-free plants and grass areas. From seals and filters that protect your system from debris to materials specially engineered to withstand harsh chemicals, these products are built to a standard the competition can't match.



Customized Coverage for Landscapes—and More

Offering a full range of sizes and options, Rain Bird® sprays, rotors and drip irrigation products provide a solution for every irrigation challenge. Whether you're watering flower beds or taking a precise new approach to tee boxes, Rain Bird has you covered.



RD1800™ Series Spray Heads

FEATURES

- Patented Triple-Blade Wiper Seal precisely balances flushing, flow-by and debris protection to optimize performance and durability at pop-up and retraction, clearing debris and ensuring positive stem retraction in all soil types.
- Unique debris pockets hold grit in place, removing it from circulation and preventing long-term damage.
- Parts resistant to corrosion for use in treated recycle water containing chlorine.

RD1800 SAM PRS Series

Incorporates all RD1800 Series SAM and PRS features. Meets the needs of all spray areas, regardless of changing elevation or water pressures.

RD1800 Flow-Shield™ Series

Provides low flow vertical water jet visible from +200' line of sight when a nozzle has been removed.

RD1800 Non-Potable Water Series

Provides an alternative to clip-on caps and molded purple covers. Easy-to-read English "DO NOT DRINK" and Spanish "NO BEBA" warnings and international do not drink symbol.

SPECIFICATIONS

Operating Range:

Spacing: 2.5' to 24' (0.8 m to 7.3 m)

Pressure: 15 to 100 psi (1.0 to 6.9 bar)

Dimensions:

RD04 Series: 4" (10.2 cm) pop-up height; 6" (15.0 cm) body height

RD06 Series: 6" (15.0 cm) pop-up height; 9 3/8" (23.8 cm) body height

RD12 Series: 12" (30.5 cm) pop-up height; 16" (40.6 cm) body height

Inlet: 1/2" (15/21) NPT female threaded

SAM Capability: Holds up to 14 feet (4.2 m) of head; 6 psi (0.3 bar)

Flow-By:

SAM Models: 0 at 15 psi (1.0 bar) or greater; 0.5 gpm (0.03 l/s; 0.1 m³/h) otherwise

All Other Models: 0 at 10 psi (0.7 bar) or greater; 0.5 gpm (0.03 l/s; 0.1 m³/h) otherwise

Pressure Regulation: SAM-PRS models regulate to an average 30 or 45 psi (2.1 or 3.1 bar) with inlet pressures of up to 100 psi (6.9 bar)

Side Inlets: SAM models only

Warranty: 5-year trade warranty

Models

4"	6"	12"
RD-04	—	—
RD-04-NP	—	—
RD-04-S-P-30	RD-06-S-P-30	RD-12-S-P-30
RD-04-S-P-30-NP	RD-06-S-P-30-NP	RD-12-S-P-30-NP
RD-04-S-P-30-F	RD-06-S-P-30-F	RD-12-S-P-30-F
RD-04-S-P-30-F-NP	RD-06-S-P-30-F-NP	RD-12-S-P-30-F-NP
RD-04-S-P-45-NP	RD-06-S-P-45-NP	RD-12-S-P-45-NP
RD-04-S-P-45-F	RD-06-S-P-45-F	RD-12-S-P-45-F
RD-04-S-P-45-F-NP	RD-06-S-P-45-F-NP	RD-12-S-P-45-F-NP

HOW TO SPECIFY

RD-XX	-	X(XX)	-	Nozzle
POP-UP HEIGHT 04 = 4" (10.2 cm) 06 = 6" (15.0 cm) 12 = 12" (30.5 cm)		OPTIONAL FEATURES S = SAM P-30 = 30 psi (2.1 bar) in-stem pressure regulation P-45 = 45 psi (3.1 bar) in-stem pressure regulation F = Flow-Shield™ technology NP = Non-potable water use indicating cover		COMPATIBLE NOZZLES See Rotary Nozzle, U-Series and HE-VAN Nozzle specifications for more information.

Flow-Shield™ Technology available in P30 and P45 models only. Specify sprinkler bodies and nozzles separately.



1800® Series Spray Heads

FEATURES

- Co-molded wiper seal provides unmatched resistance to grit, pressures and the environment.
- Constructed of time-proven UV-resistant plastic and corrosion-resistant stainless steel parts, ensuring long product life.
- Precision-controlled flush at pop-down clears debris from unit, assuring positive stem retraction in all soil types.
- Two-piece ratchet mechanism allows easy nozzle patter alignment and provides added durability.

1800 PRS Series

PRS pressure regulator built into the stem maintains a constant outlet pressure of 30 psi (2.1 bar). Eliminates misting and fogging caused by high pressure.

1800 SAM Series

Built-in Seal-A-Matic™ (SAM) check valve eliminates the need for under-the-head check valves. Traps water in lateral pipes in elevation changes of up to 14 ft (4.2 m).

1800 SAM PRS Series

Incorporates all 1800 Series SAM and PRS features. Meets the needs of all spray areas, regardless of changing elevation or water pressures.

1800 SAM-P45 Series

Maintains a constant outlet pressure of 45 psi (3.1 bar) at varying inlet pressures. Maintains constant pressure regardless of nozzle used.

SPECIFICATIONS

Operating Range:

Spacing: 2.5' to 24' (0.8 m to 7.3 m)*

Pressure: 15 to 70 psi (1.0 to 4.8 bar)

Dimensions:

1802 Series: 2" (5.1 cm) pop-up height; 4" (10.2 cm) body height

1804 Series: 4" (10.2 cm) pop-up height; 6" (15.0 cm) body height

1806 Series: 6" (15.0 cm) pop-up height; 9 3/8" (23.8 cm) body height

1812 Series: 12" (30.5 cm) pop-up height; 16" (40.6 cm) body height

Inlet: 1/2" (15/21) NPT female threaded

Exposed Surface Diameter: 2 1/4" (5.7 cm)

SAM Capability: Holds up to 14 feet (4.2 m) of head; 6 psi (0.3 bar)

Flow-By: 0 gpm at 8 psi (0.6 bar) or greater; 0.10 gpm (0.36 l/m; 0.02 m³/h) otherwise

Pressure Regulation: SAM-PRS models regulate to an average 30 or 45 psi (2.1 or 3.1 bar) with inlet pressures of up to 70 psi (4.8 bar)

Side Inlets: SAM models only

Warranty: 5-year trade warranty

HOW TO SPECIFY

18XX

POP-UP HEIGHT
02 = 2" (5.1 cm)
04 = 4" (10.2 cm)
06 = 6" (15.0 cm)
12 = 12" (30.5 cm)

XXX

OPTIONAL FEATURE
SAM = Seal-A-Matic
check valve
PRS = Pressure
regulator

XXX

OPTIONAL FEATURE
PRS = Pressure regulator
P45 = 45 psi pressure
regulator



R-VAN Rotary Nozzles

FEATURES

- Adjust arc and radius without tools.
- Color-coded for easy identification.
- Low precipitation rate reduces run-off and erosion.
- Maintains efficient performance at high operating pressures without misting or fogging.
- Exclusive manual flush makes it easy to clear dirt and debris in seconds.
- Compatible with all models of Rain Bird spray bodies in addition to a wide variety of risers and adapters.
- Matched precipitation rates across radius and arcs simplify the design process and enable large and small turf areas to be zoned together by mixing R-VAN, R-Series and 5000 Series Rotors with the MPR nozzle set.



SPECIFICATIONS

Models:

8' to 14' (2.4 m to 4.6 m)

R-VAN14: Blue top, 45° – 270° Adjustable Arc

R-VAN14-360: Blue top, 360° Full-Circle

13' to 18' (4.0 m to 5.5 m)

R-VAN18: 45° to 270° Adjustable Arc

R-VAN18-360: 360° Full-Circle

17' to 24' (5.2 m to 7.3 m)

R-VAN24: 45° to 270° Adjustable Arc

R-VAN24-360: 360° Full-Circle

Strip Nozzles

R-VAN-LCS: 5' x 15' (1.5 m x 4.6 m) Left Corner Strip

R-VAN-RCS: 5' x 15' (1.5 m x 4.6 m) Right Corner Strip

R-VAN-SST: 5' x 30' (1.5 m x 9.1 m) Side Strip

Pressure Range: 30 to 55 psi (2.1 to 3.8 bar)

Recommended Operating Pressure: 45 psi (3.1 bar)*

Spacing: 8' to 24' (2.4 m to 7.3 m)

Adjustments: Arc and radius should be adjusted while water is running

Warranty: 3-year trade warranty



HOW TO SPECIFY

R-VAN	–	XX(X)-XXX
MODEL		RADIUS RANGE / ARC
R-VAN = Rotary Variable Arc Nozzle		14 = 8' to 14' (2.4 m to 4.6 m) 45° to 270° Variable Arc
		14-360 = 8' to 14' (2.4 m to 4.6 m) 360° Full-Circle
		18 = 13' to 18' (4.0 m to 5.5 m) 45° to 270° Variable Arc
		18-360 = 13' to 18' (4.0 m to 5.5 m) 360° Full-Circle
		24 = 17' to 24' (5.2 m to 7.3 m) 45° to 270° Variable Arc
		24-360 = 17' to 24' (5.2 m to 7.3 m) 360° Full-Circle
		LCS = 5' x 15' (1.5 m x 4.6 m)
		RCS = 5' x 15' (1.5 m x 4.6 m)
		SST = 5' x 30' (1.5 m x 9.1 m)

U.S. Performance Data

R-VAN14 ADJUSTABLE ARC NOZZLES																											
	270° Arc						210° Arc						180° Arc						90° Arc								
Pressure (psi)	30	35	40	45	50	55	30	35	40	45	50	55	30	35	40	45	50	55	30	35	40	45	50	55			
Radius (ft)	13	13	14	14	15	15	13	13	14	14	15	15	13	13	14	14	15	15	13	13	14	14	15	15			
Flow (gpm)	0.84	0.87	0.92	0.94	1.11	1.17	0.65	0.68	0.72	0.73	0.86	0.91	0.56	0.58	0.61	0.63	0.74	0.78	0.28	0.29	0.31	0.32	0.37	0.39			
■ Precipitation (in/h)	0.64	0.66	0.60	0.62	0.63	0.67	0.64	0.66	0.60	0.62	0.63	0.67	0.64	0.66	0.60	0.62	0.63	0.67	0.64	0.66	0.62	0.61	0.63	0.67			
▲ Precipitation (in/h)	0.76	0.74	0.71	0.70	0.73	0.77	0.76	0.74	0.71	0.70	0.73	0.77	0.76	0.74	0.71	0.70	0.73	0.77	0.76	0.74	0.71	0.70	0.73	0.77			

Metric Performance Data

R-VAN14 ADJUSTABLE ARC NOZZLES																											
	270° Arc						210° Arc						180° Arc						90° Arc								
Pressure (bar)	2.1	2.4	2.8	3.1	3.4	3.8	2.1	2.4	2.8	3.1	3.4	3.8	2.1	2.4	2.8	3.1	3.4	3.8	2.1	2.4	2.8	3.1	3.4	3.8			
Radius (m)	4.0	4.0	4.3	4.3	4.6	4.6	4.0	4.0	4.3	4.3	4.6	4.6	4.0	4.0	4.3	4.3	4.6	4.6	4.0	4.0	4.3	4.3	4.6	4.6			
Flow (l/m)	3.2	3.3	3.5	3.6	4.2	4.4	2.5	2.6	2.7	2.8	3.3	3.4	2.1	2.2	2.3	2.4	2.8	3.0	1.1	1.1	1.2	1.2	1.4	1.5			
■ Precipitation (mm/h)	16	17	15	16	16	17	16	17	15	16	16	17	16	17	15	16	16	17	16	17	16	15	16	17			
▲ Precipitation (mm/h)	19	19	18	18	19	20	19	19	18	18	19	20	19	19	18	18	19	20	19	19	18	18	19	20			

U.S. Performance Data

R-VAN14-360 FULL-CIRCLE NOZZLES						
	360° Arc					
Pressure (psi)	30	35	40	45	50	55
Radius (ft)	13	13	14	14	15	15
Flow (gpm)	1.1	1.1	1.2	1.3	1.4	1.5
■ Precipitation (in/h)	0.63	0.64	0.60	0.62	0.60	0.62
▲ Precipitation (in/h)	0.72	0.74	0.69	0.72	0.70	0.72

Metric Performance Data

R-VAN14-360 FULL-CIRCLE NOZZLES						
	360° Arc					
Pressure (bar)	2.1	2.4	2.8	3.1	3.4	3.8
Radius (m)	4.0	4.0	4.3	4.3	4.6	4.6
Flow (l/m)	4.2	4.2	4.6	4.8	5.3	5.5
■ Precipitation (mm/h)	16	16	15	16	15	16
▲ Precipitation (mm/h)	18	19	18	18	18	18

8' to 14' | 2.4 m to 4.6 m



R-VAN14 | 45°-270°

R-VAN14-360 | 360°

LANDSCAPE SOLUTIONS

U.S. Performance Data

R-VAN18 ADJUSTABLE ARC NOZZLES																								
	270° Arc						210° Arc						180° Arc						90° Arc					
Pressure (psi)	30	35	40	45	50	55	30	35	40	45	50	55	30	35	40	45	50	55	30	35	40	45	50	55
Radius (ft)	16	16	17	17	18	18	16	16	17	17	18	18	16	16	17	17	18	18	16	16	17	17	18	18
Flow (gpm)	1.26	1.35	1.42	1.51	1.57	1.62	0.98	1.05	1.10	1.17	1.22	1.26	0.85	0.91	0.98	1.01	1.07	1.09	0.42	0.47	0.50	0.50	0.54	0.58
■ Precipitation (in/h)	0.65	0.64	0.63	0.64	0.60	0.60	0.63	0.68	0.63	0.64	0.62	0.64	0.65	0.64	0.63	0.64	0.60	0.60	0.65	0.64	0.63	0.64	0.60	0.60
▲ Precipitation (in/h)	0.75	0.74	0.73	0.73	0.69	0.69	0.73	0.78	0.73	0.77	0.72	0.74	0.75	0.74	0.73	0.73	0.69	0.69	0.75	0.74	0.73	0.73	0.69	0.69

Metric Performance Data

R-VAN18 ADJUSTABLE ARC NOZZLES																								
	270° Arc						210° Arc						180° Arc						90° Arc					
Pressure (bar)	2.1	2.4	2.8	3.1	3.4	3.8	2.1	2.4	2.8	3.1	3.4	3.8	2.1	2.4	2.8	3.1	3.4	3.8	2.1	2.4	2.8	3.1	3.4	3.8
Radius (m)	4.9	4.9	5.2	5.2	5.5	5.5	4.9	4.9	5.2	5.2	5.5	5.5	4.9	4.9	5.2	5.2	5.5	5.5	4.9	4.9	5.2	5.2	5.5	5.5
Flow (l/m)	4.77	5.11	5.38	5.72	5.94	6.13	3.71	3.97	4.16	4.43	4.62	4.77	3.22	3.44	3.71	3.82	4.05	4.13	1.59	1.78	1.89	1.89	2.04	2.20
■ Precipitation (mm/h)	17	16	16	16	15	15	16	17	16	16	16	16	17	16	16	16	15	15	17	16	16	16	15	15
▲ Precipitation (mm/h)	19	19	18	18	18	18	19	20	19	20	18	19	19	19	18	18	18	18	19	19	18	18	18	18

U.S. Performance Data

R-VAN18-360 FULL-CIRCLE NOZZLES						
	360° Arc					
Pressure (psi)	30	35	40	45	50	55
Radius (ft)	16	16	17	17	18	18
Flow (gpm)	1.65	1.67	1.80	1.85	2.05	2.11
■ Precipitation (in/h)	0.62	0.63	0.60	0.62	0.61	0.63
▲ Precipitation (in/h)	0.72	0.73	0.69	0.71	0.70	0.72

Metric Performance Data

R-VAN18-360 FULL-CIRCLE NOZZLES						
	360° Arc					
Pressure (bar)	2.1	2.4	2.8	3.1	3.4	3.8
Radius (m)	4.9	4.9	5.2	5.2	5.5	5.5
Flow (l/m)	6.25	6.32	6.81	7.00	7.76	7.99
■ Precipitation (mm/h)	16	16	15	16	15	16
▲ Precipitation (mm/h)	18	19	18	18	18	18

13' to 18' | 4.0 m to 5.5 m



R-VAN18 | 45° – 270°

R-VAN18-360 | 360°

U.S. Performance Data

R-VAN24 ADJUSTABLE ARC NOZZLES																											
	270° Arc						210° Arc						180° Arc						90° Arc								
Pressure (psi)	30	35	40	45	50	55	30	35	40	45	50	55	30	35	40	45	50	55	30	35	40	45	50	55			
Radius (ft)	16	16	17	17	18	18	16	16	17	17	18	18	16	16	17	17	18	18	16	16	17	17	18	18			
Flow (gpm)	1.26	1.35	1.42	1.51	1.57	1.62	0.98	1.05	1.10	1.17	1.22	1.26	0.85	0.91	0.98	1.01	1.07	1.09	0.42	0.47	0.50	0.50	0.54	0.58			
■ Precipitation (in/h)	0.65	0.64	0.63	0.64	0.60	0.60	0.63	0.68	0.63	0.64	0.62	0.64	0.65	0.64	0.63	0.64	0.60	0.60	0.65	0.64	0.63	0.64	0.60	0.60			
▲ Precipitation (in/h)	0.75	0.74	0.73	0.73	0.69	0.69	0.73	0.78	0.73	0.77	0.72	0.74	0.75	0.74	0.73	0.73	0.69	0.69	0.75	0.74	0.73	0.73	0.69	0.69			

Metric Performance Data

R-VAN24 ADJUSTABLE ARC NOZZLES																											
	270° Arc						210° Arc						180° Arc						90° Arc								
Pressure (bar)	2.1	2.4	2.8	3.1	3.4	3.8	2.1	2.4	2.8	3.1	3.4	3.8	2.1	2.4	2.8	3.1	3.4	3.8	2.1	2.4	2.8	3.1	3.4	3.8			
Radius (m)	4.9	4.9	5.2	5.2	5.5	5.5	4.9	4.9	5.2	5.2	5.5	5.5	4.9	4.9	5.2	5.2	5.5	5.5	4.9	4.9	5.2	5.2	5.5	5.5			
Flow (l/m)	4.77	5.11	5.38	5.72	5.94	6.13	3.71	3.97	4.16	4.43	4.62	4.77	3.22	3.44	3.71	3.82	4.05	4.13	1.59	1.78	1.89	1.89	2.04	2.20			
■ Precipitation (mm/h)	17	16	16	16	15	15	16	17	16	16	16	16	17	16	16	16	15	15	17	16	16	16	15	15			
▲ Precipitation (mm/h)	19	19	18	18	18	18	19	20	19	20	18	19	19	19	18	18	18	18	19	19	18	18	18	18			

U.S. Performance Data

R-VAN24-360 FULL-CIRCLE NOZZLES						
	360° Arc					
Pressure (psi)	30	35	40	45	50	55
Radius (ft)	16	16	17	17	18	18
Flow (gpm)	1.65	1.67	1.80	1.85	2.05	2.11
■ Precipitation (in/h)	0.62	0.63	0.60	0.62	0.61	0.63
▲ Precipitation (in/h)	0.72	0.73	0.69	0.71	0.70	0.72

Metric Performance Data

R-VAN24 360 FULL-CIRCLE NOZZLES						
	360° Arc					
Pressure (bar)	2.1	2.4	2.8	3.1	3.4	3.8
Radius (m)	4.9	4.9	5.2	5.2	5.5	5.5
Flow (l/m)	6.25	6.32	6.81	7.00	7.76	7.99
■ Precipitation (mm/h)	16	16	15	16	15	16
▲ Precipitation (mm/h)	18	19	18	18	18	18

17' to 24' | 5.2 m to 7.3 m



R-VAN24 | 45° – 270°

R-VAN24-360 | 360°

LANDSCAPE SOLUTIONS

U.S. Performance Data

R-VAN-LCS LEFT CORNER STRIP / R-VAN RCS RIGHT CORNER STRIP						
	 <p style="text-align: center;">5' x 15'</p>					
Pressure (psi)	30	35	40	45	50	55
Size (ft)	4 x 14	5 x 15	5 x 15	5 x 15	5 x 15	6 x 16
Flow (gpm)	0.18	0.22	0.23	0.24	0.25	0.28
— Precipitation (in/h)	0.62	0.56	0.59	0.62	0.64	0.56
▲ Precipitation (in/h)	0.62	0.56	0.59	0.62	0.64	0.56

Metric Performance Data

R-VAN-LCS LEFT CORNER STRIP						
	1.5 m x 4.6 m					
Pressure (bar)	2.1	2.4	2.8	3.1	3.4	3.8
Size (m)	1.2 x 4.3	1.5 x 4.6	1.5 x 4.6	1.5 x 4.6	1.5 x 4.6	1.8 x 4.9
Flow (l/m)	0.68	0.83	0.87	0.91	0.95	1.06
— Precipitation (mm/h)	16	14	15	16	16	14
▲ Precipitation (mm/h)	16	14	15	16	16	14

5' x 15' | 1.5 m x 4.6 m



R-VAN-LCS | Left Corner Strip

R-VAN-LCS | Left Corner Strip

U.S. Performance Data

R-VAN-SST SIDE STRIP						
	 <p style="text-align: center;">5' x 30'</p>					
Pressure (psi)	30	35	40	45	50	55
Size (ft)	4 x 28	5 x 30	5 x 30	5 x 30	5 x 30	6 x 32
Flow (gpm)	0.36	0.44	0.46	0.48	0.50	0.56
— Precipitation (in/h)	0.62	0.56	0.59	0.62	0.64	0.56
▲ Precipitation (in/h)	0.62	0.56	0.59	0.62	0.64	0.56

Metric Performance Data

R-VAN-SST SIDE STRIP						
	1.5 m x 9.1 m					
Pressure (bar)	2.1	2.4	2.8	3.1	3.4	3.8
Size (m)	1.2 x 8.5	1.5 x 9.1	1.5 x 9.1	1.5 x 9.1	1.5 x 9.1	1.8 x 9.8
Flow (l/m)	1.36	1.67	1.74	1.82	1.89	2.12
— Precipitation (mm/h)	16	14	15	16	16	14
▲ Precipitation (mm/h)	16	14	15	16	16	14

5' x 30' | 1.5 m x 9.1 m



R-VAN-LCS | Left Corner Strip

HE-VAN Series Nozzles

FEATURES

- High-Efficiency Variable Arc (HE-VAN) nozzles have even coverage that allows you to shorten run times by up to 35%, while still maintaining a healthy lawn. HE-VAN has more than a 40% even-coverage improvement over existing variable arc nozzles.
- Low-trajectory spray and large water droplets prevent misting and airborne evaporation so the right amount of water is delivered to the right place. Gentle close-in watering eliminates dry spots around the spray head.
- Unique stream pattern that throws to the exact specified radius, delivering the cleanest edge of any VAN on the market today.
- Reduced zone run times help stay within tight watering windows, conserve water and save money.
- With full adjustability from 0° to 360°, you'll be able to efficiently water landscapes of all shapes while stocking fewer nozzles.
- Matched precipitation rates allow you to install Rain Bird® HE-VAN, MPR and U-Series nozzles on the same zone.

SPECIFICATIONS

Models:

- HE-VAN-08:** Green top; 6' to 8' (1.8 m to 2.4 m)
- HE-VAN-10:** Blue top; 8' to 10' (2.4 m to 3.0 m)
- HE-VAN-12:** Brown top; 9' to 12' (2.7 m to 3.7 m)
- HE-VAN-15:** Black top; 12' to 15' (3.7 m to 4.6 m)

Radius: Adjustable, 0° to 360°

Pressure Range: 15 to 30 psi (1.0 to 2.1 bar)

Recommended Operating Pressure: 30 psi (2.1 bar)*

Spacing: 6' to 15' (1.8 m to 2.4 m)

Adjustment: Tactile click keeps arc setting from drifting over time





Warranty: 3-year trade warranty

HOW TO SPECIFY

HE	-	VAN	-	XX
MODEL		FEATURE		RADIUS RANGE
HE = High-Efficiency Nozzle		VAN = Variable Arc		08 = 6–8 ft (1.8–2.4 m)
				10 = 8–10 ft (2.4–3.0 m)
				12 = 9–12 ft (2.7–3.7 m)
				15 = 12–15 ft (3.7–4.6 m)







U.S. Performance Data

8 SERIES HE-VAN — 24° TRAJECTORY																
	 360° Arc				 270° Arc				 180° Arc				 90° Arc			
Pressure (psi)	15	20	25	30	15	20	25	30	15	20	25	30	15	20	25	30
Radius (ft)	5	6	7	8	5	6	7	8	5	6	7	8	5	6	7	8
Flow (gpm)	0.83	0.96	1.07	1.17	0.62	0.72	0.80	0.88	0.41	0.48	0.53	0.59	0.21	0.24	0.27	0.29
■ Precipitation (in/h)	3.19	2.56	2.10	1.76	3.19	2.56	2.10	1.76	3.19	2.56	2.10	1.76	3.19	2.56	2.10	1.76
▲ Precipitation (in/h)	3.68	2.95	2.42	2.03	3.68	2.95	2.42	2.03	3.68	2.95	2.42	2.03	3.68	2.95	2.42	2.03

Metric Performance Data

8 SERIES HE-VAN — 24° TRAJECTORY																
	360° Arc				270° Arc				180° Arc				90° Arc			
Pressure (bar)	1.03	1.38	1.72	2.07	1.03	1.38	1.72	2.07	1.03	1.38	1.72	2.07	1.03	1.38	1.72	2.07
Radius (m)	1.52	1.83	2.13	2.44	1.52	1.83	2.13	2.44	1.52	1.83	2.13	2.44	1.52	1.83	2.13	2.44
Flow (l/m)	3.14	3.62	4.05	4.43	2.35	2.72	3.04	3.33	1.57	1.81	2.02	2.22	0.78	0.91	1.01	1.11
Flow (m³/h)	0.19	0.22	0.25	0.27	0.14	0.16	0.18	0.20	0.10	0.11	0.12	0.13	0.05	0.05	0.06	0.07
■ Precipitation (mm/h)	82	66	54	45	82	66	54	45	82	66	54	45	82	66	54	45
▲ Precipitation (mm/h)	95	76	62	52	95	76	62	52	95	76	62	52	95	76	62	52





U.S. Performance Data

10 SERIES HE-VAN — 27° TRAJECTORY																
	 360° Arc				 270° Arc				 180° Arc				 90° Arc			
Pressure (psi)	15	20	25	30	15	20	25	30	15	20	25	30	15	20	25	30
Radius (ft)	7	8	9	10	7	8	9	10	7	8	9	10	7	8	9	10
Flow (gpm)	1.26	1.46	1.63	1.78	0.95	1.09	1.22	1.34	0.63	0.73	0.81	0.89	0.32	0.36	0.41	0.45
■ Precipitation (in/h)	2.48	2.19	1.94	1.72	2.48	2.19	1.94	1.72	2.48	2.19	1.94	1.72	2.48	2.19	1.94	1.72
▲ Precipitation (in/h)	2.86	2.53	2.24	1.98	2.86	2.53	2.24	1.98	2.86	2.53	2.24	1.98	2.86	2.53	2.24	1.98

Metric Performance Data

10 SERIES HE-VAN — 27° TRAJECTORY																
	360° Arc				270° Arc				180° Arc				90° Arc			
Pressure (bar)	1.03	1.38	1.72	2.07	1.03	1.38	1.72	2.07	1.03	1.38	1.72	2.07	1.03	1.38	1.72	2.07
Radius (m)	2.13	2.44	2.74	3.05	2.13	2.44	2.74	3.05	2.13	2.44	2.74	3.05	2.13	2.44	2.74	3.05
Flow (l/m)	4.78	5.52	6.17	6.76	3.59	4.14	4.63	5.07	2.39	2.76	3.09	3.38	1.20	1.38	1.54	1.69
Flow (m³/h)	0.29	0.34	0.37	0.41	0.22	0.25	0.28	0.31	0.15	0.17	0.19	0.21	0.07	0.08	0.09	0.10
■ Precipitation (mm/h)	64	56	50	44	64	56	50	44	64	56	50	44	64	56	50	44
▲ Precipitation (mm/h)	74	65	57	51	74	65	57	51	74	65	57	51	74	65	57	51





U.S. Performance Data

12 SERIES HE-VAN — 23° TRAJECTORY																
	 360° Arc				 270° Arc				 180° Arc				 90° Arc			
Pressure (psi)	15	20	25	30	15	20	25	30	15	20	25	30	15	20	25	30
Radius (ft)	9	10	11	12	9	10	11	12	9	10	11	12	9	10	11	12
Flow (gpm)	1.67	1.93	2.16	2.37	1.25	1.45	1.62	1.77	0.84	0.97	1.08	1.18	0.42	0.48	0.54	0.59
■ Precipitation (in/h)	1.99	1.86	1.72	1.58	1.99	1.86	1.72	1.58	1.99	1.86	1.72	1.58	1.99	1.86	1.72	1.58
▲ Precipitation (in/h)	2.30	2.15	1.99	1.83	2.30	2.15	1.99	1.83	2.30	2.15	1.99	1.83	2.30	2.15	1.99	1.83

Metric Performance Data

12 SERIES HE-VAN — 23° TRAJECTORY																
	360° Arc				270° Arc				180° Arc				90° Arc			
Pressure (bar)	1.0	1.4	1.7	2.1	1.0	1.4	1.7	2.1	1.0	1.4	1.7	2.1	1.0	1.4	1.7	2.1
Radius (m)	2.7	3.0	3.4	3.7	2.7	3.0	3.4	3.7	2.7	3.0	3.4	3.7	2.7	3.0	3.4	3.7
Flow (l/m)	6.33	7.31	8.18	8.96	4.75	5.48	6.16	6.72	3.17	3.66	4.09	4.48	1.58	1.83	2.04	2.24
Flow (m³/h)	0.38	0.44	0.49	0.54	0.28	0.33	0.37	0.40	0.19	0.22	0.25	0.27	0.09	0.11	0.12	0.13
■ Precipitation (mm/h)	50.5	47.3	43.7	40.2	50.5	47.3	43.7	40.2	50.5	47.3	43.7	40.2	50.5	47.3	43.7	40.2
▲ Precipitation (mm/h)	58.3	54.6	50.4	46.4	58.3	54.6	50.4	46.4	58.3	54.6	50.4	46.4	58.3	54.6	50.4	46.4

U.S. Performance Data

15 SERIES HE-VAN — 25° TRAJECTORY																
	 360° Arc				 270° Arc				 180° Arc				 90° Arc			
Pressure (psi)	15	20	25	30	15	20	25	30	15	20	25	30	15	20	25	30
Radius (ft)	11	12	14	15	11	12	14	15	11	12	14	15	11	12	14	15
Flow (gpm)	2.62	3.02	3.38	3.70	1.96	2.27	2.53	2.78	1.31	1.51	1.69	1.85	0.65	0.76	0.84	0.93
■ Precipitation (in/h)	2.08	2.02	1.66	1.58	2.08	2.02	1.66	1.58	2.08	2.02	1.66	1.58	2.08	2.02	1.66	1.58
▲ Precipitation (in/h)	2.40	2.33	1.92	1.83	2.40	2.33	1.92	1.83	2.40	2.33	1.92	1.83	2.40	2.33	1.92	1.83

Metric Performance Data

15 SERIES HE-VAN — 25° TRAJECTORY																
	360° Arc				270° Arc				180° Arc				90° Arc			
Pressure (bar)	1.0	1.4	1.7	2.1	1.0	1.4	1.7	2.1	1.0	1.4	1.7	2.1	1.0	1.4	1.7	2.1
Radius (m)	3.4	3.7	4.3	4.6	3.4	3.7	4.3	4.6	3.4	3.7	4.3	4.6	3.4	3.7	4.3	4.6
Flow (l/m)	9.91	11.44	12.79	14.01	7.43	8.58	9.59	10.51	4.95	5.72	6.39	7.00	2.48	2.86	3.20	3.50
Flow (m³/h)	0.59	0.69	0.77	0.84	0.45	0.51	0.58	0.63	0.30	0.34	0.38	0.42	0.15	0.17	0.19	0.21
■ Precipitation (mm/h)	52.9	51.3	42.2	40.2	52.9	51.3	42.2	40.2	52.9	51.3	42.2	40.2	52.9	51.3	42.2	40.2
▲ Precipitation (mm/h)	61.1	59.3	48.7	46.5	61.1	59.3	48.7	46.5	61.1	59.3	48.7	46.5	61.1	59.3	48.7	46.5

NOTE: All HE-VAN Nozzles tested on 4" (10.2 cm) pop-ups. Radius reduction over 25% of the normal throw of the nozzle is not recommended.
■ Square and ▲ triangular spacing based on 50% diameter of throw. Performance data taken in zero wind conditions.

U-Series Nozzles

FEATURES

- Additional orifice for close-in watering minimizes brown spots around the spray head and eliminates gaps in coverage so the entire watering area is more uniformly covered.
- Superior coverage for efficient watering. Use up to 30% less water.
- Matched precipitation rate with Rain Bird HE-VAN and MPR nozzles.

SPECIFICATIONS

Operating Range:

Spacing: 5' to 15' (1.7 m to 4.6 m)

Pressure: 15 to 30 psi (1.0 to 2.1 bar)

Models:

U-8: Green top; 5' to 8' (1.7 m to 2.4 m)

U-10: Blue top; 7' to 10' (2.1 m to 3.0 m)

U-12: Brown top; 9' to 12' (2.7 m to 3.7 m)

U-15: Black top; 12' to 15' (3.7 m to 4.6 m)

Warranty: 5-year trade warranty



U-Series nozzles offer better, more uniform water distribution. Water flowing from both orifices combines to form a continuous water stream, thereby eliminating gaps for more uniform coverage throughout the entire watering area.

HOW TO SPECIFY

U	XX	X
MODEL	RADIUS RANGE	PATTERN
U-Series Nozzle	8 = 5' to 8' (1.7 m to 2.4 m) 10 = 7' to 10' (2.1 m to 3.0 m) 12 = 9' to 12' (2.7 m to 3.7 m) 15 = 11' to 15' (3.4 m to 4.6 m)	F = Full H = Half Q = Quarter





U.S. Performance Data

U-SERIES FULL-CIRCLE PATTERN					
		Pressure (psi)	Radius (ft)	Flow (gpm)	Precipitation (in/hr)
					■ ▲
	U-8F (10° Trajectory)	15	5	0.74	2.85 3.29
		20	6	0.86	2.30 2.66
		25	7	0.96	1.89 2.18
		30	8	1.05	1.58 1.83
	U-10F (12° Trajectory)	15	7	1.16	2.07 2.39
		20	8	1.34	2.01 2.32
		25	9	1.50	1.62 1.87
		30	10	1.64	1.58 1.83
	U-12F (23° Trajectory)	15	9	1.80	2.14 2.47
		20	10	2.10	2.02 2.34
		25	11	2.40	1.91 2.21
		30	12	2.60	1.74 2.01
	U-15F (23° Trajectory)	15	11	2.60	2.07 2.39
		20	12	3.00	2.01 2.32
		25	14	3.30	1.62 1.87
		30	15	3.70	1.58 1.83

Metric Performance Data

U-SERIES FULL-CIRCLE PATTERN						
		Pressure (bar)	Radius (m)	Flow (l/m)	Flow (m³/h)	Precipitation (mm/hr)
						■ ▲
		1.0	1.7	2.8	0.16	72 84
		1.5	2.1	3.4	0.20	58 68
		2.0	2.4	3.9	0.23	48 55
		2.1	2.4	4.0	0.24	40 46
		1.0	2.1	4.4	0.226	52 60
		1.5	2.6	5.3	0.30	47 55
		2.0	3.0	6.1	0.34	41 48
		2.1	3.1	6.2	0.37	40 46
		1.0	2.7	6.8	0.40	55 63
		1.5	3.2	8.3	0.48	47 54
		2.0	3.6	9.7	0.59	46 53
		2.1	3.7	9.8	0.60	44 51
		1.0	3.4	9.8	0.60	52 60
		1.5	3.9	11.8	0.72	47 55
		2.0	4.5	13.7	0.84	41 48
		2.1	4.6	14.0	0.84	40 46





U.S. Performance Data

U-SERIES HALF CIRCLE PATTERN					
	Pressure (psi)	Radius (ft)	Flow (gpm)	Precipitation (in/hr)	
				■	▲
 U-8H (10° Trajectory)	15	5	0.37	2.85	3.29
	20	6	0.42	2.25	2.59
	25	7	0.47	1.85	2.13
	30	8	0.52	1.58	1.83
 U-10H (12° Trajectory)	15	7	0.58	2.07	2.39
	20	8	0.67	2.01	2.32
	25	9	0.75	1.62	1.87
	30	10	0.82	1.58	1.83
 U-12H (23° Trajectory)	15	9	0.90	2.14	2.47
	20	10	1.05	2.02	2.34
	25	11	1.20	1.91	2.21
	30	12	1.30	1.74	2.01
 U-15H (23° Trajectory)	15	11	1.30	2.07	2.39
	20	12	1.50	2.01	2.32
	25	14	1.65	1.62	1.87
	30	15	1.85	1.58	1.83

Metric Performance Data

U-SERIES HALF CIRCLE PATTERN					
Pressure (bar)	Radius (m)	Flow (l/m)	Flow (m³/h)	Precipitation (mm/hr)	
				■	▲
1.0	1.7	1.4	0.08	72	84
1.5	2.1	1.7	0.10	57	66
2.0	2.4	1.9	0.12	47	54
2.1	2.4	2.0	0.12	40	46
1.0	2.1	2.2	0.13	52	60
1.5	2.6	2.6	0.15	47	55
2.0	3.0	3.1	0.17	41	48
2.1	3.1	3.1	0.19	40	46
1.0	2.7	3.4	0.20	55	63
1.5	3.2	4.2	0.24	47	54
2.0	3.6	4.8	0.30	46	53
2.1	3.7	4.9	0.30	44	51
1.0	3.4	4.9	0.30	52	60
1.5	3.9	5.9	0.36	47	55
2.0	4.5	6.9	0.42	41	48
2.1	4.6	7.0	0.42	40	46

U.S. Performance Data

U-SERIES QUARTER CIRCLE PATTERN					
	Pressure (psi)	Radius (ft)	Flow (gpm)	Precipitation (in/hr)	
				■	▲
 U-8Q (10° Trajectory)	15	5	0.18	2.77	3.20
	20	6	0.21	2.25	2.59
	25	7	0.24	1.89	2.18
	30	8	0.26	1.58	1.83
 U-10Q (12° Trajectory)	15	7	0.29	2.07	2.39
	20	8	0.33	2.01	2.32
	25	9	0.37	1.62	1.87
	30	10	0.41	1.58	1.83
 U-12Q (23° Trajectory)	15	9	0.45	2.14	2.47
	20	10	0.53	2.02	2.34
	25	11	0.60	1.91	2.21
	30	12	0.65	1.74	2.01
 U-15Q (23° Trajectory)	15	11	0.65	2.07	2.39
	20	12	0.75	2.01	2.32
	25	14	0.82	1.62	1.87
	30	15	0.92	1.58	1.83

Metric Performance Data

U-SERIES QUARTER CIRCLE PATTERN					
Pressure (bar)	Radius (m)	Flow (l/m)	Flow (m³/h)	Precipitation (mm/hr)	
				■	▲
1.0	1.7	0.7	0.04	70	81
1.5	2.1	0.8	0.05	57	66
2.0	2.4	1.0	0.06	48	55
2.1	2.4	1.0	0.06	40	46
1.0	2.1	1.1	0.07	52	60
1.5	2.6	1.3	0.08	47	55
2.0	3.0	1.5	0.08	41	48
2.1	3.1	1.6	0.09	40	46
1.0	2.7	1.7	0.10	55	63
1.5	3.2	2.1	0.12	47	54
2.0	3.6	2.4	0.15	46	53
2.1	3.7	2.5	0.15	44	51
1.0	3.4	2.5	0.15	52	60
1.5	3.9	2.9	0.18	47	55
2.0	4.5	3.4	0.21	41	48
2.1	4.6	3.5	0.21	40	46

5000 Series Rotors

FEATURES

- Oversized wiper seal prevents leaks and protects internals from debris.
- Rain Curtain™ nozzles deliver even distribution over the entire radius including large wind resistant droplets and gentle close-in watering resulting in greener turf using less water.
- A history of proven performance and reliability tested in millions of installations.
- Self-flushing arc adjustment port that prevents buildup of debris.
- Models available in Part-Circle and reversing Full-Circle (PC) or non-reversing Full-Circle (FC).

SPECIFICATIONS

Models:

5004: 4" (10.2 cm) pop-up height; 7 3/8" (18.73 cm) body height

5006: 6" (15.2 cm) pop-up height; 9 5/8" (24.5 cm) body height

5012: 12" (30.5 cm) pop-up height; 16 7/8" (42.9 cm) body height

Plus: Flow shut-off

Shrub: Mounted above ground on a 3/4" fixed threaded riser

Precipitation Rate: 0.20 to 1.50 in/hr (5 to 38 mm/h)

Radius: 25' to 50' (7.6 m to 15.2 m)*

Pressure: 25 to 65 psi (1.7 to 4.5 bar)

Flow Rate: 0.76 to 9.63 gpm (3.0 to 36.6 l/m; 0.17 to 2.19 m³/h)

Inlet: 3/4" (20/27) NPT female threaded

Warranty: 5-year trade warranty

*Radius may be reduced up to 25% with radius reduction screw.



HOW TO SPECIFY

50XX	-	X	-	X	-	XX	-	XXX	-	X	-	XX	-	XX
MODEL		MODEL		MODEL		ROTATION		OPTION		OPTION		OPTION		MODEL
5004: 4" pop-up		+ = Plus		S = Shrub		PC = 40° - 360°		SAM = Seal-A-Matic™		R = PRS		NP = Non-Potable Cover		SS = Stainless Steel
5006: 6" pop-up						FC = 360°								
5012: 12" pop-up														



U.S. Performance Data

STANDARD ANGLE RAIN CURTAIN™ NOZZLE PERFORMANCE					
Pressure psi	Nozzle	Radius ft	Flow gpm	Precipitation	
				■ in/h	▲ in/h
25	1.5	33	1.12	0.20	0.23
	2.0	35	1.50	0.24	0.27
	2.5	35	1.81	0.28	0.33
	3.0	36	2.26	0.34	0.39
	4.0	36	2.91	0.43	0.49
	5.0	37	3.72	0.52	0.60
	6.0	37	4.25	0.60	0.69
	8.0	33	5.90	1.26	1.50
35	1.5	34	1.35	0.22	0.26
	2.0	36	1.81	0.27	0.31
	2.5	37	2.17	0.31	0.35
	3.0	38	2.71	0.36	0.42
	4.0	40	3.50	0.42	0.49
	5.0	41	4.47	0.51	0.59
	6.0	43	5.23	0.54	0.63
	8.0	41	7.06	0.94	1.10
45	1.5	35	1.54	0.24	0.28
	2.0	37	2.07	0.29	0.34
	2.5	37	2.51	0.35	0.41
	3.0	39	3.09	0.37	0.43
	4.0	42	4.01	0.44	0.51
	5.0	43	5.09	0.48	0.56
	6.0	44	6.01	0.59	0.69
	8.0	44	8.03	0.92	1.06
55	1.5	35	1.71	0.27	0.31
	2.0	37	2.30	0.32	0.37
	2.5	37	2.76	0.39	0.45
	3.0	40	3.47	0.42	0.48
	4.0	42	4.44	0.48	0.56
	5.0	45	5.66	0.54	0.62
	6.0	50	6.63	0.51	0.59
	8.0	47	8.86	0.80	0.93
65	1.5	34	1.86	0.31	0.36
	2.0	35	2.52	0.40	0.46
	2.5	37	3.01	0.42	0.49
	3.0	40	3.78	0.45	0.53
	4.0	42	4.83	0.53	0.61
	5.0	45	6.16	0.59	0.68
	6.0	50	7.22	0.55	0.64
	8.0	48	9.63	0.84	0.97

Precipitation based on half-circle operation.

■ Square and ▲ triangular spacing based on 50% diameter of throw.

Performance data collected in zero wind conditions.

Metric Performance Data

STANDARD ANGLE RAIN CURTAIN™ NOZZLE PERFORMANCE						
Pressure bar	Nozzle	Radius m	Flow		Precipitation	
			l/m	m³/h	■ mm/h	▲ mm/h
2.0	1.5	10.2	4.8	0.28	5	6
	2.0	10.8	6.0	0.36	6	7
	2.5	10.9	7.2	0.44	7	9
	3.0	11.2	9.0	0.55	9	10
	4.0	11.6	12.0	0.71	11	12
	5.0	12.1	15.0	0.91	13	15
	6.0	12.4	17.4	1.05	15	17
	8.0	11.8	24.0	1.45	32	37
2.5	1.5	10.4	5.4	0.31	6	7
	2.0	11.0	6.6	0.41	7	8
	2.5	11.3	8.4	0.50	8	9
	3.0	11.2	10.2	0.62	9	11
	4.0	12.3	13.2	0.81	11	13
	5.0	12.7	17.4	1.03	13	15
	6.0	13.2	20.4	1.21	14	16
	8.0	13.3	27.0	1.63	24	28
3.0	1.5	10.6	6.0	0.34	6	7
	2.0	11.2	7.8	0.45	7	8
	2.5	11.3	9.6	0.56	9	10
	3.0	12.1	11.4	0.69	9	11
	4.0	12.7	15.0	0.89	11	13
	5.0	13.5	18.6	1.13	12	14
	6.0	13.4	22.2	1.34	13	17
	8.0	13.4	30.0	1.79	23	27
3.5	1.5	10.7	6.0	0.37	7	8
	2.0	11.3	8.4	0.49	8	9
	2.5	11.3	10.2	0.60	9	11
	3.0	12.2	12.6	0.74	10	12
	4.0	12.8	16.2	0.97	12	14
	5.0	13.7	20.4	1.23	13	15
	6.0	14.2	24.0	1.45	13	15
	8.0	14.9	32.4	1.93	20	24
4.0	1.5	10.6	6.6	0.40	7	8
	2.0	11.1	9.0	0.52	8	10
	2.5	11.3	10.8	0.64	10	12
	3.0	12.2	13.2	0.80	11	12
	4.0	12.8	17.4	1.04	13	15
	5.0	13.7	22.2	1.32	14	16
	6.0	14.9	25.8	1.55	14	16
	8.0	15.2	34.2	2.06	21	25
4.5	1.5	10.4	7.2	0.42	8	9
	2.0	10.7	9.0	0.55	10	11
	2.5	11.3	11.4	0.68	11	12
	3.0	12.2	13.8	0.84	11	13
	4.0	12.8	18.0	1.10	13	15
	5.0	13.7	23.4	1.40	15	17
	6.0	14.6	28.2	1.64	15	18
	8.0	15.2	36.6	2.19	19	22

5000 Series MPR Nozzles

FEATURES

- Rain Curtain™ nozzles deliver even distribution over the entire radius including large wind resistant droplets and gentle close-in watering resulting in greener turf using less water.
- Precipitation rate is automatically matched with a uniform radius that does not require stream deflection.
- Matched 0.6"/hour precipitation rates enable large and small turf areas to be zoned together by mixing rotors and Rain Bird® R-VAN or R-Series rotary nozzles.

SPECIFICATIONS

Models:





5000MPRMPK: 5000/5000 Plus Series MPR nozzle tree multi pack.
25' (red), 30' (green) and 35' (beige) radius. Each tree contains Quarter, Third, Half and Full arcs.



HOW TO SPECIFY

5000	-	MPR	-	XX	-	X
MODEL		NOZZLE		RADIUS RANGE		PATTERN
Rotors		Matched		25'		Q = Quarter
		Precipitation		30'		T = Third
		Rate		35'		H = Half
						F = Full





U.S. Performance Data

5000-MPR-25 (RED)																				
																				
	Quarter					Third					Half					Full				
Pressure (psi)	25	35	45	55	65	25	35	45	55	65	25	35	45	55	65	25	35	45	55	65
Radius (ft)	23	24	25	25	25	23	24	25	25	25	23	24	25	25	25	23	24	25	25	25
Flow (gpm)	0.74	0.88	1.00	1.11	1.21	1.00	1.21	1.38	1.53	1.67	1.44	1.73	1.98	2.21	2.41	2.78	3.34	3.82	4.25	4.63
■ Precipitation (in/h)	0.54	0.59	0.62	0.68	0.75	0.55	0.61	0.64	0.71	0.77	0.52	0.58	0.61	0.68	0.74	0.51	0.56	0.59	0.65	0.71
▲ Precipitation (in/h)	0.62	0.68	0.71	0.79	0.86	0.63	0.70	0.74	0.82	0.89	0.61	0.67	0.70	0.79	0.86	0.58	0.64	0.68	0.76	0.82

Metric Performance Data

5000-MPR-25 (RED)																				
	Quarter					Third					Half					Full				
Pressure (bar)	1.7	2.4	3.1	3.8	4.5	1.7	2.4	3.1	3.8	4.5	1.7	2.4	3.1	3.8	4.5	1.7	2.4	3.1	3.8	4.5
Radius (m)	7.0	7.3	7.6	7.6	7.6	7.0	7.3	7.6	7.6	7.6	7.0	7.3	7.6	7.6	7.6	7.0	7.3	7.6	7.6	7.6
Flow (l/m)	3.0	3.6	3.6	4.2	4.8	3.6	4.8	5.4	6.0	6.6	5.4	6.6	7.2	8.4	9.0	10.8	12.6	14.4	16.2	17.4
Flow (m³/h)	0.17	0.20	0.23	0.25	0.27	0.23	0.27	0.31	0.35	0.38	0.33	0.39	0.45	0.50	0.55	0.63	0.76	0.87	0.97	1.05
■ Precipitation (mm/h)	13.7	14.9	15.6	17.4	18.9	13.9	15.4	16.2	18.0	19.6	13.3	14.7	15.5	17.3	18.9	12.8	14.2	14.9	16.6	18.1
▲ Precipitation (mm/h)	15.8	17.3	18.1	20.1	21.9	16.0	17.8	18.7	20.7	22.6	15.4	17.0	17.9	20.0	21.8	14.8	16.4	17.3	19.2	20.9





U.S. Performance Data

5000-MPR-30 (GREEN)																				
	 Quarter					 Third					 Half					 Full				
Pressure (psi)	25	35	45	55	65	25	35	45	55	65	25	35	45	55	65	25	35	45	55	65
Radius (ft)	29	30	30	30	30	29	30	30	30	30	29	30	30	30	30	29	30	30	30	30
Flow (gpm)	1.03	1.23	1.40	1.56	1.69	1.34	1.62	1.85	2.06	2.24	2.15	2.59	2.96	3.30	3.60	4.24	5.08	5.78	6.39	6.92
■ Precipitation (in/h)	0.47	0.53	0.60	0.67	0.72	0.46	0.52	0.59	0.66	0.72	0.49	0.55	0.63	0.71	0.77	0.49	0.54	0.62	0.68	0.74
▲ Precipitation (in/h)	0.54	0.61	0.69	0.77	0.83	0.53	0.60	0.69	0.76	0.83	0.57	0.64	0.73	0.82	0.89	0.56	0.63	0.71	0.79	0.85

Metric Performance Data

5000-MPR-30 (GREEN)																				
	Quarter					Third					Half					Full				
Pressure (bar)	1.7	2.4	3.1	3.8	4.5	1.7	2.4	3.1	3.8	4.5	1.7	2.4	3.1	3.8	4.5	1.7	2.4	3.1	3.8	4.5
Radius (m)	8.8	9.1	9.1	9.1	9.1	8.8	9.1	9.1	9.1	9.1	8.8	9.1	9.1	9.1	9.1	8.8	9.1	9.1	9.1	9.1
Flow (l/m)	3.6	4.8	5.4	6.0	6.6	4.8	6.0	7.2	7.8	8.4	8.4	9.6	11.4	12.6	13.8	16.2	19.2	21.6	24.0	26.4
Flow (m³/h)	0.23	0.28	0.32	0.35	0.38	0.30	0.37	0.42	0.47	0.51	0.49	0.59	0.67	0.75	0.82	0.96	1.15	1.31	1.45	1.57
■ Precipitation (mm/h)	12.0	13.4	15.2	17.0	18.4	11.7	13.2	15.1	16.8	18.3	12.5	14.1	16.1	17.9	19.6	12.3	13.8	15.7	17.4	18.8
▲ Precipitation (mm/h)	13.8	15.4	17.6	19.6	21.2	13.5	15.2	17.4	19.4	21.1	14.4	16.2	18.6	20.7	22.6	14.2	15.9	18.1	20.0	21.7

U.S. Performance Data

5000-MPR-35 (BEIGE)																				
	 Quarter					 Third					 Half					 Full				
Pressure (psi)	25	35	45	55	65	25	35	45	55	65	25	35	45	55	65	25	35	45	55	65
Radius (ft)	32	34	35	35	35	32	34	35	35	35	32	34	35	35	35	32	34	35	35	35
Flow (gpm)	1.40	1.67	1.92	2.13	2.31	1.77	2.15	2.46	2.74	2.99	2.75	3.33	3.81	4.23	4.62	5.36	6.62	7.58	8.43	9.18
■ Precipitation (in/h)	0.53	0.56	0.60	0.67	0.73	0.50	0.54	0.58	0.65	0.70	0.52	0.55	0.60	0.66	0.73	0.50	0.55	0.60	0.66	0.72
▲ Precipitation (in/h)	0.61	0.64	0.70	0.77	0.84	0.58	0.62	0.67	0.75	0.81	0.60	0.64	0.69	0.77	0.84	0.58	0.64	0.69	0.76	0.83

Metric Performance Data

5000-MPR-35 (BEIGE)																				
	Quarter					Third					Half					Full				
Pressure (bar)	1.7	2.4	3.1	3.8	4.5	1.7	2.4	3.1	3.8	4.5	1.7	2.4	3.1	3.8	4.5	1.7	2.4	3.1	3.8	4.5
Radius (m)	9.8	10.4	10.7	10.7	10.7	9.8	10.4	10.7	10.7	10.7	9.8	10.4	10.7	10.7	10.7	9.8	10.4	10.7	10.7	10.7
Flow (l/m)	5.4	6.6	7.2	7.8	9.0	6.6	8.4	9.6	10.2	11.4	10.2	12.6	14.4	16.2	17.4	20.4	25.2	28.8	31.8	34.8
Flow (m³/h)	0.32	0.38	0.44	0.48	0.52	0.40	0.49	0.56	0.62	0.68	0.62	0.76	0.87	0.96	1.05	1.22	1.50	1.72	1.91	2.09
■ Precipitation (mm/h)	13.4	14.1	15.3	17.0	18.4	12.7	13.6	14.7	16.4	17.9	13.1	14.1	15.2	16.9	18.4	12.8	14.0	15.1	16.8	18.3
▲ Precipitation (mm/h)	15.4	16.3	17.7	19.6	21.3	14.6	15.8	17.0	18.9	20.7	15.2	16.3	17.6	19.5	21.3	14.8	16.2	17.5	19.4	21.2

Root Watering System (RWS)

FEATURES

- Subsurface aeration and irrigation prevents tree and shrub transplant shock.
- Highest efficiency solution for tree irrigation — up to 95% emission uniformity with minimal wind, evaporation or edge control losses.
- Aesthetically designs subsurface bubbler contributes to a landscape's natural appearance.
- Locking grate at grade deters vandals.
- Helps prevent shallow root growth and hardscape damage.
- Aesthetically attractive below-grade installation.
- Self-contained and factory-assembled units for assured reliability.

SPECIFICATIONS

RWS

Dimensions:

Length: 36" (91.4 cm) semi-rigid mesh tube

Top Diameter: 4" (10.2 cm) retaining cap with vandal-resistant locking grate

Bubbler Options: On a factory-installed swing assembly with fixed riser

1401: 0.25 gpm; 0.95 l/m

1402: 0.5 gpm; 1.9 l/m

1404: 1.0 gpm; 3.8 l/m

Options:

Check Valve: Keep lines from draining

Sand Sock: For use in fine soils

RWS-Mini

Dimensions:

Length: 18" (45.7 cm) semi-rigid mesh tube

Top Diameter: 4" (10.2 cm) retaining cap with vandal-resistant locking grate

Bubbler Options: On a factory-installed ½" spiral barb elbow

1401: 0.25 gpm; 0.95 l/m

1402: 0.5 gpm; 1.9 l/m

Options:

Check Valve: Keep lines from draining

Sand Sock: For use in fine soils

RWS-Supplemental

Dimensions:

Length: 10" (25.4 cm) semi-rigid mesh tube

Top Diameter: 2" (5.1 cm) snap-on cap and base cap

Bubbler Options: On a factory-installed ½" spiral barb elbow

PCT: Pressure-compensating ½" FPT inlet (0.08 gpm; 0.32 l/m)

1401: 0.25 gpm; 0.95 l/m

Options:

Check Valve: Keep lines from draining

Sand Sock: For use in fine soils

HOW TO SPECIFY

MODEL	MODEL	BUBBLER	OPTION	BUBBLER MODEL
RWS	M = Mini S = Supplemental	B = Bubbler preinstalled	C = Check Valve	1401 = 0.25 gpm (0.95 l/m) 1402 = 0.50 gpm (1.9 l/m) 1404 = 1.00 gpm (3.8 l/m)



RWS-Sock

Designed to fit over the outside of the unit. Ideal for use in sandy soil, it will deter fine soil from infiltrating the RWS canister.



RWS integrated collar and locking grate retainer.

RWS Models / Specifications

Model	Bubbler	Check Valve*	Swing Assembly	Spiral Barb Elbow
Root Watering System — 36" (91.4 cm) with 4" (10.2 cm) vandal-resistant locking grate				
RWS	¼" drip tubing or customer-provided hardware	—	—	—
RWS-B-C-1401	0.25 gpm (0.95 l/m)	✓	✓	—
RWS-B-1401	0.25 gpm (0.95 l/m)	—	✓	—
RWS-B-C-1402	0.50 gpm (1.9 l/m)	✓	✓	—
RWS-B-1402	0.50 gpm (1.9 l/m)	—	✓	—
RWS-B-C-1404	1.00 gpm (3.8 l/m)	✓	✓	—
Root Watering System-Mini — 18" (45.7 cm) with 4" (10.2 cm) vandal-resistant locking grate				
RWS-M	¼" drip tubing or customer-provided hardware	—	—	—
RWS-M-B-C-1401	0.25 gpm (0.95 l/m)	✓	—	✓
RWS-M-B-1401	0.25 gpm (0.95 l/m)	—	—	✓
RWS-M-B-C-1402	0.50 gpm (1.9 l/m)	✓	—	✓
RWS-M-B-1402	0.50 gpm (1.9 l/m)	—	—	✓
Root Watering System-Supplemental — 10" (25.4 cm) with 2" (5.1 cm) pop-on cap and base				
RWS-S-B-C-1401	0.25 gpm (0.95 l/m)	✓	—	✓
RWS-S-B-1401	0.25 gpm (0.95 l/m)	—	—	✓

Accessories

RWS-SOCK = Root Watering Sock

RWS-GRATE-P = Purple grate for RWS and RWS-Mini

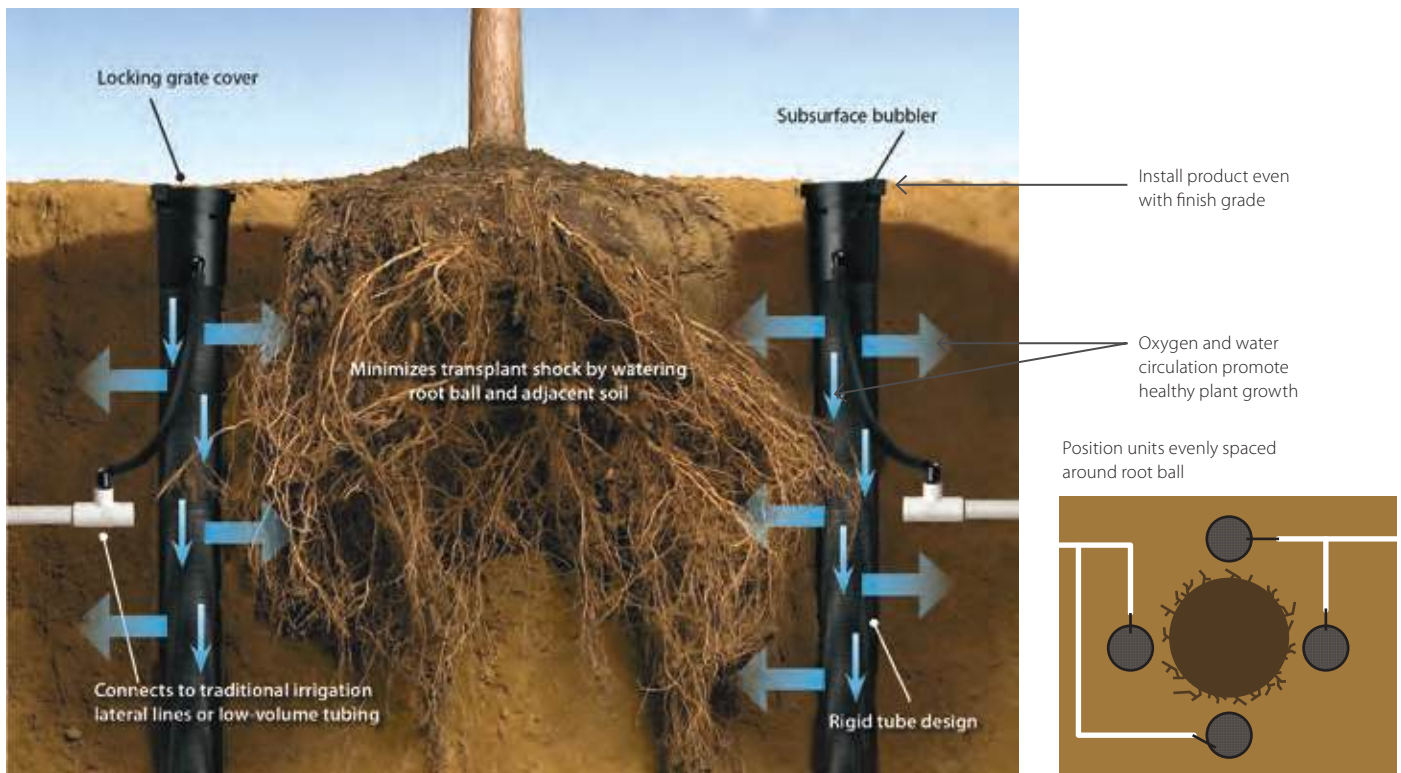

XFS-CV Dripline with Heavy-Duty Check Valve

Rain Bird® XFS-CV Dripline with an improved 4.3 psi check valve delivers 10 feet of hold-back—the highest in the industry. With pure copper chips in every emitter to protect against emitter root intrusion, XFS-CV Dripline is an all-in-one dripline suitable for any application—on-surface, sub-surface, sloped or level-grade. When used in applications where elevation changes exist, the patent-pending check valve keeps the dripline charged with water, delivering better irrigation uniformity while preventing over-watering and puddling at the low-point in the zone. A proprietary tubing material makes the XFS Sub-Surface Dripline with Copper Shield™ the most flexible tubing in the industry, and the easiest sub-surface dripline to design with and install.

Accepts Rain Bird XF Dripline Barbed Insert Fittings and other 17 mm barbed insert fittings.

FEATURES

Simple

- Rain Bird's patent-pending 4.3 psi check valve technology keeps the dripline charged with water at all times, increasing uniformity of watering, and conserves water by eliminating the need to recharge the line at the beginning of each watering cycle.
- XFS-CV Sub-Surface Dripline emitters are protected from root intrusion by Rain Bird's patent-pending Copper Shield Technology resulting in a system that does not require maintenance or replacement of chemicals to prevent root intrusion. Through the use of a proprietary tubing material, the XFS-CV Dripline with heavy-duty check valve is the most flexible dripline tubing in the industry, making it the easiest dripline to design with and install.
- Rain Bird's low-profile emitter design reduces in-line pressure loss, allowing longer lateral runs, simplifying design and reducing installation time.
- Variety of standard emitter flow rates, emitter spacing and coil lengths provide design flexibility for sub-surface and on-surface areas with or without elevation changes.

Made with Recycled Content

- All Rain Bird XF Dripline (XFD, XFS, XFCV, XFS-CV) qualify for LEED credit 4.2 because they contain at least 20% Polyethylene post-consumer-recycled-material by cost. These come in an assortment of coil sizes, flow rates and emitter spacing.

Reliable

- The pressure-compensating emitter design provides a consistent flow over the entire lateral length ensuring higher uniformity for increased reliability in the pressure range of 20 to 60 psi.

Durable

- Dual-layered tubing (copper over black) provides unmatched resistance to chemicals, algae growth and UV damage.

Grit Tolerant

- Rain Bird's proprietary emitter design resists clogging by use of an extra-wide flow path combined with a self-flushing action.



OPERATING RANGE

Opening Pressure: 14.5 psi

Pressure: 20 to 60 psi (1.38 to 4.14 bar)

Flow rates: 0.6 and 0.9 gph (2.3 l/hr and 3.5 l/hr)

Temperature:

Water: Up to 100°F (37.8° C)

Ambient: Up to 125°F (51.7° C)

Required Filtration: 120 mesh

SPECIFICATIONS

Dimensions:

OD: 0.634" (16mm)

ID: 0.536" (13.6mm);

Thickness: 0.049" (1.2mm)

Spacing: 12" or 18" (30.5 cm, 45.7 cm)

Coil Length: 100', 250' and 500' (30.5 m, 76.2 m and 152.4 m)

Coil Colors: Copper, purple, purple stripe

HOW TO SPECIFY

XFS-CV	-	X(X)	-	XX	-	XX	-	XXX
MODEL Dripline with Heavy-Duty Check Valve		OPTIONAL P = Purple PS = Purple Stripe		FLOW RATE 06 = 0.61 gph (2.3 l/h) 09 = 0.92 gph (3.5 l/h)		EMITTER SPACING 12 = 12" (30.5 cm) 18 = 18" (45.7 cm)		COIL LENGTH 100 = 100' (30.5 m) 250 = 250' (76.2 m) 500 = 500' (152.4 m)

Compatible Fittings

See page 84 for more information.



XF Dripline Insert Fittings

U.S. Performance Data

MAXIMUM LATERAL LENGTH (FEET)				
	12" Spacing		18" Spacing	
	Nominal Flow (gph)		Nominal Flow (gph)	
Inlet Pressure (psi)	0.6	0.9	0.6	0.9
20	192	136	254	215
30	289	205	402	337
40	350	248	498	416
50	397	281	573	477
60	436	309	637	529

Metric Performance Data

MAXIMUM LATERAL LENGTH (METERS)				
	30.5 cm Spacing		45.7 cm Spacing	
	Nominal Flow (l/h)		Nominal Flow (l/h)	
Inlet Pressure (bar)	2.3	3.4	2.3	3.4
1.4	59	41	77	66
2.1	88	63	123	103
2.8	107	76	152	127
3.5	121	86	175	145
4.1	133	94	194	161

QF Dripline Header

A quick and flexible replacement for site-built header, the QF Dripline Header is a patent-pending product that is the landscape industry's first pre-fabricated header for dripline installations. Using a proprietary blend of polyethylene, similar to Rain Bird's XF Series Dripline, the QF Dripline Header allows installers to simply roll out the header and attach the dripline at a guaranteed 12" or 18" spacing — eliminating the need for measuring, cutting, gluing and taping.

FEATURES

- Header elbows rotate 360° and incorporate a protective ring — preventing damage and ensuring a proper seal.
- Rotating barb manages trenching misalignment — move left or right to accommodate the dripline without the need to retrench.
- Elbows utilize the same design as Rain Bird's popular XFF Fitting, requiring 50% less insertion force, and are compatible with the XFF Fittings Tool.

SPECIFICATIONS

¾" QF Header

Dimensions:

OD: 0.94" (23.9 mm)

ID: 0.82" (20.8 mm)

Thickness: 0.06" (1.5 mm)

Spacing: 12" or 18"
(30.5 cm or 45.7 cm)

Coil Length: 100' (30.5 m)

Coil Colors: Copper or Purple

1" QF Header

Dimensions:

OD: 1.20" (30.5 mm)

ID: 1.06" (26.9 mm)

Thickness: 0.07" (1.8 mm)

Spacing: 12" or 18"
(30.5 cm or 45.7 cm)

Coil Length: 100' (30.5 m)

Coil Colors: Copper or Purple

Models

Coil	12" Spacing		18" Spacing	
	¾" Dripline	1" Dripline	¾" Dripline	1" Dripline
100'	XQF7512100	XQF1012100	XQF7518100	XQF1018100
100' Purple	—	XQF101210P	—	XQF101810P

HOW TO SPECIFY

XQF	—	XX	—	XX	—	XXX
MODEL		DIAMETER		EMITTER SPACING		COIL LENGTH
XQF = Xerigation Quick Flexible		75 = ¾" 10 = 1"		12 = 12" (30.5 cm) 18 = 18" (45.7 cm)		100 = 100' (30.5 m) 10P = 100' (30.5 m) Purple

Compatible Fittings

See page 84 for more information.



¾" QF Header:

Twist Lock Fittings 800 Series



1" QF Header:

Twist Lock Fittings 1000 Series

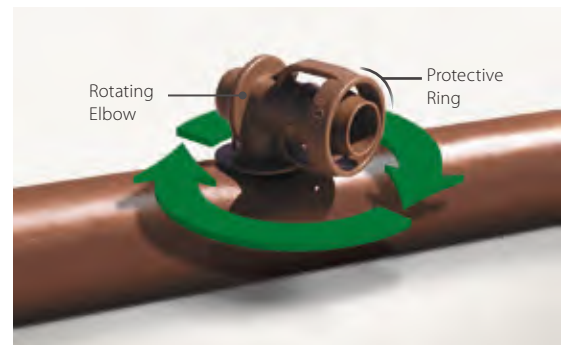

XFD On-Surface Dripline

FEATURES

- Extra flexible tubing for fast, easy installation.
- Dual-layered tubing (brown over black or purple over black) provides unmatched resistance to chemicals, UV damage and algae growth.
- Patent-pending emitter design provides for increased reliability.
- Longer lateral runs than the competition.
- Unique material offers significantly greater flexibility, allowing tighter turns with fewer elbows for easier installation.
- Choice of flow rates, spacing and coil lengths provides design flexibility for a variety of non-turfgrass applications.

SPECIFICATIONS

Dimensions:

OD: 0.634" (16.1 mm)

ID: 0.536" (13.6 mm)

Thickness: 0.049" (1.2 mm)

Spacing: 12" or 18" (30.5 cm or 45.7 cm)

Coil Lengths: 100' (30.5 m), 250' (76.2 m), and 500' (152.4 m)

Coil Colors: Copper or Purple

Operating Range:

Pressure: 8.5 to 60 psi (0.58 to 4.1 bar)

Flow Rates: 0.6 and 0.9 gph (2.3 and 3.5 l/hr)

Temperature:

Water: Up to 100° F (37.8° C)

Ambient: Up to 125° F (51.7° C)

Required Filtration: 120 mesh

Compatible Fittings: XF Dripline Insert Fittings, Rain Bird Easy Fit Compression Fittings or Twist Lock Fittings (See page 84 for more information)



HOW TO SPECIFY

XFD	-	X	-	XX	-	XX	-	XXX
MODEL		OPTIONAL		FLOW RATE		EMITTER SPACING		COIL LENGTH
XFD = Xerigation Flexible Dripline		P = Purple		06 = 0.61 gph (2.3 l/h) 09 = 0.92 gph (3.5 l/h)		12 = 12" (30.5 cm) 18 = 18" (45.7 cm)		100 = 100' (30.5 m) 250 = 250' (76.2 m) 500 = 500' (152.4 m)



Twist Lock Fittings

- Simplify installation of QF Header, Dripline and Blank Distribution Tubing.
- Fittings provide an even tighter seal on tubing by using high quality barbs and twist locking nuts.
- Unique barb design reduces insertion force while maintaining a secure fit.

SPECIFICATIONS

Pressure: 0 to 60 psi (0 to 4.1 bar)

MODELS

600 Series

- TLF-CUPL-0600:** ½" Coupler
- TLF-TEE-0600:** ½" Tee
- TLF-ELBW-0600:** ½" Elbow
- TLF-MPT6-0600:** ½" NPT to ½" Adapter
- TLF-MPT8-0600:** ¾" NPT to ½" Adapter

800 Series

- TLF-CUPL-0800:** ¾" Coupler
- TLF-TEE-0800:** ¾" Tee
- TLF-ELBW-0800:** ¾" Elbow
- TLF-MPT8-0800:** ¾" NPT Adapter
- TLF-CAP-0800:** ¾" Cap

1000 Series

- TLF-CUPL-1000:** 1" Coupler
- TLF-TEE-1000:** 1" Tee
- TLF-ELBW-1000:** 1" Elbow
- TLF-MPT1-1000:** 1" NPT Adapter



XF Dripline Insert Fittings



- Complete line of 17 mm insert fittings to simplify installation of XF Series Dripline.
- Unique barb design reduces insertion force and still retain a secure fit.
- Non-obtrusive colored fittings to compliment natural earth tones.

SPECIFICATIONS

Pressure: 0 to 50 psi (1.0 to 3.5 bar); If using 60 psi (4.1 bar), clamps will be required

MODELS

- XFF-COUP:** 17 mm Barb x Barb Coupling
- XFF-ELBOW:** 17 mm Barb x Barb Elbow
- XFF-MA-050:** 17 mm Barb x ½" MPT Male Adapter
- XFF-TEE:** 17 mm Barb x Barb x Barb Tee
- XFF-TMA-050:** 17 mm Barb x ½" MPT x 17 mm Barb Tee Male Adapter
- XFF-MA-075:** 17 mm Barb x ¾" MPT Male Adapter
- XFF-FA-050:** Low-Profile Barb Elbow Female Adapter 17 mm x ½" FPT
- XFF-TFA-050:** Low-Profile Barb Tee Female Adapter 17 mm x ½" FPT x 17 mm
- XFD-CROSS:** Barb Cross 17 mm x 17 mm x 17 mm x 17 mm
- XFS-TFA-075:** Barb Tee Female Adapter 17 mm x ¾" FPT x 17 mm
- FITTINGS-TOOL:** XF Fitting Insertion Tool. Compatible with XFF-COUP, XFF-ELBOW, XFF-TEE and QF Dripline Header.

Easy Fit Compression System



- Multi-diameter compression fittings work with a wide range of 16 mm to 17 mm tubing or dripline.
- 50% less force required to connect tubing and fittings versus competitive compression fittings. Adapters swivel for easy installation.
- Patented fittings and adapters are molded from UV-resistant and durable ABS materials.
- Removable flush caps can be used to flush end of line and temporarily cap off lines for later expansion.
- Not recommended with subsurface irrigation.

SPECIFICATIONS

Pressure: 0 to 60 psi (0 to 4.1 bar)

Tubing: Accepts tubing with an OD of 0.630" (16 mm) to 0.669" (17 mm)

MODELS

Easy Fit Fittings

- MDCF-COUP:** Coupling
- MDCF-EL:** Elbow
- MDCF-TEE:** Tee

Easy Fit Adapters

- MDCF-50MPT:** ½" Male Pipe Thread Adapter
- MDCF-75MPT:** ¾" Male Pipe Thread Adapter
- MDCF-50FPT:** ½" Female Pipe Thread Adapter
- MDCF-75FPT:** ¾" Female Pipe Thread Adapter
- MDCF-75FHT:** ¾" Female Hose Thread Adapter
- MDCF-CAP:** Black Removable Flush Cap
- MDCF-PCAP:** Purple Removable Flush Cap

NOTE: Easy Fit Adapters are not barbed fittings. They are to be used only with Easy Fit Compression Fittings.

XF Series Blank Tubing

FEATURES

- Greater flexibility is easier to install and saves time.
- Brown color matches landscape and blends with mulch.
- Compatible with XF Series Dripline (0.634" (16.1 mm) OD x 0.536" (13.6 mm) ID).
- Accepts Rain Bird® Easy Fit Compression Fittings, XF Dripline Insert Fittings and 17 mm insert fittings. Not compatible with 16 mm fittings.



SPECIFICATIONS

Dimensions:

- OD:** 0.634" (16.1 mm)
- ID:** 0.536" (13.6 mm)
- Thickness:** 0.049" (1.2 mm)

Models:

- XFD100:** 100' coil (30 m)
- XFD250:** 250' coil (76 m)
- XFD500:** 500' coil (152 m)
- XFP500:** 500' purple coil (152 m)
- XFP5500:** 500' purple stripe coil (152 m)

U.S. Performance Data

FRICTION LOSS CHARACTERISTICS (PSI/100 FT)												
	Flow (gpm)											
	0.50	1.00	1.50	2.00	2.50	3.00	3.50	4.00	4.50	5.00	5.50	6.00
Velocity (fps)	0.27	1.40	2.10	2.80	3.50	4.20	4.90	5.60	6.30	7.00	7.70	8.40
Loss (psi)	0.27	0.97	2.06	3.50	5.29	7.42	9.87	12.64	15.72	19.11	22.80	26.78

Metric Performance Data

FRICTION LOSS CHARACTERISTICS (BAR/100 M)												
	Flow (l/m)											
	1.89	3.79	5.68	7.57	9.46	11.36	13.25	15.14	17.03	18.93	20.82	22.71
Velocity (m/s)	0.21	0.43	0.64	0.85	1.07	1.28	1.49	1.71	1.92	2.13	2.35	2.56
Loss (bar)	0.06	0.22	0.46	0.79	1.20	1.68	2.23	2.86	3.56	4.32	5.16	6.06

NOTE: Use of tubing a flows shown in shaded area is not recommended, as velocities exceed 5 ft/sec (1.5 m/s).

XT-700 Distribution Tubing

FEATURES

- Thick-walled, flexible tubing resists kinks and damage caused by routine landscape maintenance activities.
- Extruded from UV-resistant polyethylene resin materials.
- Accepts Rain Bird ½" Twist Lock Fittings — 600 Series.



SPECIFICATIONS

Dimensions:

- OD:** 0.70" (18 mm)
- ID:** 0.58" (15 mm)
- Thickness:** 0.06" (1.5 mm)

Pressure: 0 to 60 psi (0 to 4.1 bar)

Models:

- XT-700-100:** 100' coil (30 m)
- XT-700-500:** 500' coil (152 m)

U.S. Performance Data

FRICTION LOSS CHARACTERISTICS (PSI/100 FT)												
	Flow (gpm)											
	0.50	1.00	1.50	2.00	2.50	3.00	3.50	4.00	4.50	5.00	5.50	6.00
Velocity (fps)	0.61	1.21	1.82	2.43	3.03	3.64	4.24	4.85	5.46	6.06	6.67	7.28
Loss (psi)	0.19	0.69	1.45	2.47	3.74	5.24	6.97	8.93	11.10	13.50	16.10	18.92

Metric Performance Data

FRICTION LOSS CHARACTERISTICS (BAR/100 M)												
	Flow (l/m)											
	1.89	3.79	5.68	7.57	9.50	11.36	13.25	15.14	17.03	18.93	20.82	22.71
Velocity (m/s)	0.19	0.37	0.56	0.74	0.92	1.11	1.29	1.48	1.67	1.85	2.03	2.22
Loss (bar)	0.01	0.05	0.10	0.17	0.26	0.36	0.48	0.62	0.77	0.93	1.11	1.31

NOTE: Use of tubing a flows shown in shaded area is not recommended, as velocities exceed 5 ft/sec (1.5 m/s).

Xeri-Bug™ with Check Valve

FEATURES

Efficient Water Usage

- With 10 feet (3 m) of hold-back power, XBCV eliminates low-point drainage and provides uniform irrigation throughout the zone.
- Strong check-valve protection helps conserve water by eliminating low-point drainage and flooding. In a standard 500-foot (152 m) line with 1/2" (13 mm) internal diameter, 20 gallons (76 L) of water is held in the line instead of draining out.
- In a zone that has a 10-foot (3 m) elevation change, only one zone is needed for the XBCV. Fewer zones allow you to save money on valves and time on installation.

Holds Prime in the Line

- Designed to hold prime in the line, these emitters immediately begin irrigation and reduce cycle times.
- By holding prime when the system is turned off, XBCV prevents particles from clogging the emitter — a problem when a system drains and siphons soiled water.
- Holding prime in the line reduces calcium build-up and extends the life of the emitter.

All-in-One Design

- With its comprehensive capabilities, the XBCV can be taken to any jobsite. It's the only emitter you need to stock, carry and install, simplifying point-source drip jobs.

Pressure Compensating

- A pressure-compensating design offers a consistent flow from 15 to 50 psi (1.0 to 3.5 bar).
- XBCV delivers the same amount of water from the first emitter in the line to the last.

Self Cleaning

- A self-flushing action cleans the emitters every time the system turns on and off, reducing maintenance and extending the life of the emitter.

Self-Piercing Barb

- Self-piercing models feature barbs that eliminate the need for a hole-punching tool, making installation easier.

Risers and Adapters

- Models with 10-32 threaded ends can quickly connect to risers or adapters.

Compact Design

- With a diameter less than a dime, the emitter is unobtrusive and easily hidden.

SPECIFICATIONS

Operating Range

Opening Pressure: 15 psi (1.0 bar)

Pressure: 15 to 50 psi (1.0 to 3.5 bar)

Flow Rates: 0.5 to 2.0 gph (1.9 to 7.6 lph)

Filtration Requirement: 150 mesh (75 micron)

Models

Self-Piercing Barb Inlet x Barb Outlet

- **XBCV-05PC:** Blue, 0.5 gph (1.9 lph)
- **XBCV-10PC:** Black, 1.0 gph (3.8 lph)
- **XBCV-20PC:** Red, 2.0 gph (7.6 lph)

10-32 Threaded Inlet x Barb Outlet

- **XBCV-05PC-1032:** Blue, 0.5 gph (1.9 lph)
- **XBCV-10PC-1032:** Black, 1.0 gph (3.8 lph)
- **XBCV-20PC-1032:** Red, 2.0 gph (7.6 lph)

HOW TO SPECIFY

XBCV - XX		PC	XXXX
MODEL	FLOW	PRESSURE COMPENSATING	OPTIONAL
Xeri-Bug	05 = 0.5 gph (1.89 l/h)		1032 = 10-32
Check Valve	10 = 1.0 gph (3.79 l/h)		Threaded Inlet
	20 = 2.0 gph (7.57 l/h)		

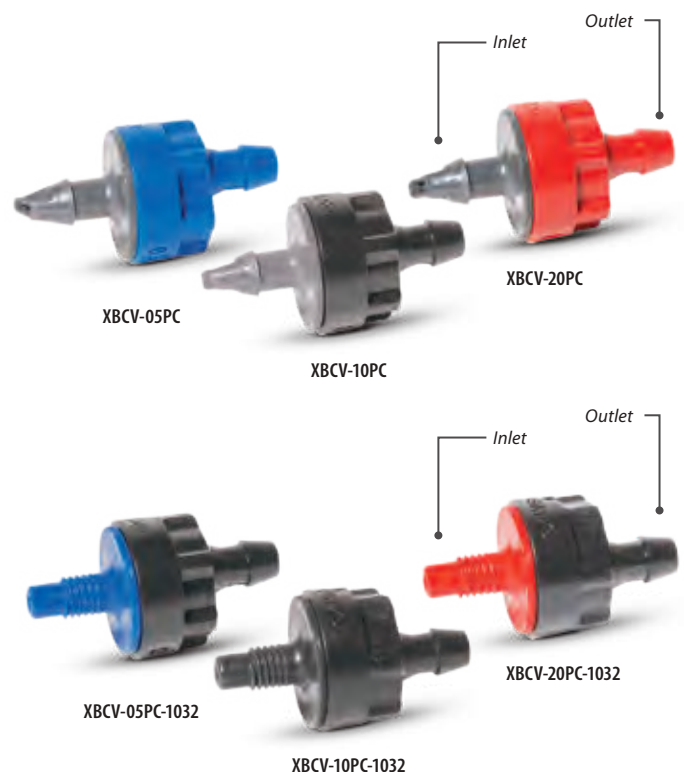

1032-threaded models are specifically designed to be used with PolyFlex Risers, 1032 thread adapters (1032-A), or 1800 Xeri-Bubbler Adapter (XBA-1800)

U.S. Performance Data

Model	Color	Nominal Flow (gph)
SELF-PIERCING BARB INLET x BARB OUTLET		
XBCV-05PC	Blue	0.5
XBCV-10PC	Black	1.0
XBCV-20PC	Red	2.0
10-32 THREADED INLET x BARB OUTLET		
XBCV-05PC-1032	Blue	0.5
XBCV-10PC-1032	Black	1.0
XBCV-20PC-1032	Red	2.0

150 mesh filtration required on all models.

Metric Performance Data

Model	Color	Nominal Flow (l/h)
SELF-PIERCING BARB INLET x BARB OUTLET		
XBCV-05PC	Blue	1.89
XBCV-10PC	Black	3.79
XBCV-20PC	Red	7.57
10-32 THREADED INLET x BARB OUTLET		
XBCV-05PC-1032	Blue	1.89
XBCV-10PC-1032	Black	3.79
XBCV-20PC-1032	Red	7.57

75 micron filtration required on all models.



Pressure Compensating: Xeri-Bug™ Emitters with Check Valve maintain a consistent flow rate from 15 to 50 psi (1.0 to 3.5 bar)

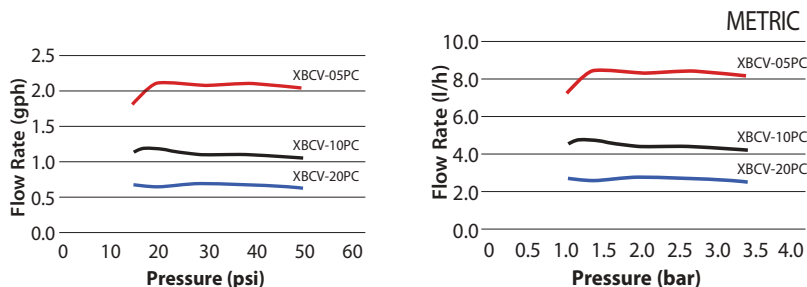

Installation Options



Option 1*

Using a Xeriman Tool, insert an emitter directly into ½" or ¾" drip tubing or between dripline emitters as needed.

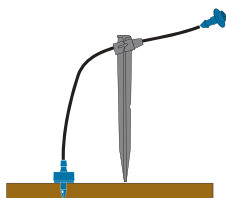

Option 2*

For more precise water placement, use ¼" distribution tubing, a ¼" tubing stake and a bug cap.

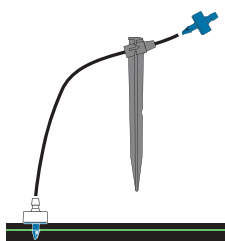

Option 3

For precise water placement, a barbed connector can be punched into distribution tubing. The emitter is then placed at the end of the ¼" distribution tubing. NOTE: should the emitter become dislodged, unregulated flow will occur.

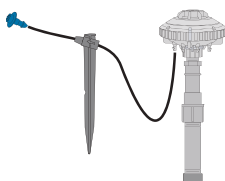

Option 4*

The Xeri-Bird 8 provides a centralized location for up to eight emitters. A mix of Xeri-Bug and/or PC emitters can be used to provide the flow rates needed for different plant materials. Tentacles of ¼" distribution tubing, ¼" tubing stakes and bug caps allow for precise water placement.

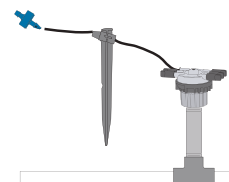

Option 5

The 6-Outlet Manifold provides a centralized water distribution connection for up to six emission devices. Connect the ¼" distribution tubing to one of the outlets. Use a ¼" tubing stake to ensure precise water placement. The emitter is placed on the end of the ¼" distribution tubing to regulate the water flow. NOTE: should the emitter become dislodged, unregulated flow will occur.

* Preferred installation options, which provide flow regulation at the source.

Xeri-Bubblers™

FEATURES

- Ideal for shrub plantings, trees, containers and flower beds.
- Adjust flow and radius by turning outer cap.
- Stream Bubbler (SXB) has wetting patterns of either half-circle, 5 stream or half-circle, 8 stream.
- Umbrella Bubbler (UXB) has a full-circle, umbrella wetting pattern.

SPECIFICATIONS

Pressure: 15 to 30 psi (1.0 to 2.1 bar)

Flow:

SXB Series: 0 to 13 gph (0 to 49.21 l/h) at 30 psi (2.1 bar); 0 to 8.5 gph (0 to 30 l/h) at 15 psi (1 bar)

UXB Series: 0 to 35 gph (0 to 132.48 l/h) at 30 psi (2.1 bar); 0 to 26 gph (0 to 98 l/h) at 15 psi (1 bar)

Models:

SXB-180: Half-circle, 5 streams, 10-32 thread

SXB-180-025: Half-circle, 5 streams, ¼" barb

SXB-180-SPYK: Half-circle, 5 streams, 5" spike; includes barb x barb coupler

SXB-360: Full-circle, 8 streams, 10-32 thread

SXB-360-025: Full-circle, 8 streams, ¼" barb

SXB-360-SPYK: Full-circle, 8 streams, 5" spike; includes barb x barb coupler

UXB-360: Full-circle, umbrella, 10-32 thread

UXB-360-025: Full-circle, umbrella, ¼" barb

UXB-360-SPYK: Full-circle, umbrella, 5" spike; includes barb x barb coupler



HOW TO SPECIFY

XXX	-	XXX	-	XXX(X)
MODEL		PATTERN		CONNECTION
SXB: Stream Bubbler		180 = Half-Circle		025 = ¼" Barb
UXB: Umbrella Bubbler		360 = Full-Circle		SPYK = 5" Spike

Xeri-Bug™ Emitters

FEATURES

- Point-source low-flow emitters Ideal for watering the root zones of shrub plantings, trees and container plants.
- Flow rates of 0.5, 1.0 and 2.0 gph (1.89, 3.79 and 7.57 l/h).
- Outlet barb securely retains ¼" distribution tubing.

SPECIFICATIONS

Operating Range:

Flow: 0.5 to 2.0 gph (1.89 to 7.57 l/h)

Pressure: 15 to 50 psi (1.0 to 3.5 bar)

Required Filtration: 150 to 200 mesh (75 to 100 micron)

Barb Inlet x Barb Outlet Models:

XB-05PC: Blue, 0.5 gph (1.89 l/h)

XB-10PC: Black, 1.0 gph (3.79 l/h)

XB-20PC: Red, 2.0 gph (7.57 l/h)

10-32 Thread Inlet x Barb Outlet Models:

XB-05PC-1032: Blue, 0.5 gph (1.89 l/h)

XB-10PC-1032: Black, 1.0 gph (3.79 l/h)

XB-20PC-1032: Red, 2.0 gph (7.57 l/h)

½" FPT Inlet x Barb Outlet Models:

XBT-10: Black, 1.0 gph (3.79 l/h)

XBT-20: Red, 2.0 gph (7.57 l/h)



HOW TO SPECIFY

XB	-	T	-	XX	-	PC	-	XXXX
MODEL		OPTIONAL		FLOW		FEATURE		OPTIONAL
XB = Xeri-Bug		T = ½" FPT Inlet		05 = 0.5 gph (1.89 l/h)		PC = Pressure Compensating		1032 = 10-32 Threaded Inlet
				10 = 1.0 gph (3.79 l/h)				
				20 = 2.0 gph (7.57 l/h)				

1.5" Inline Commercial Control Zone Kit

FEATURES

- **High Flow Range:** Allows for larger drip zone coverage with one control zone kit, saving labor cost, material cost and installation hassle.
- **Low Friction Loss:** Allows usage in zones with lower head pressure.
- **Fully Assembled:** Saves installation labor cost by ensuring all key components are included and that the direction of flow in individual components is assembled properly.
- **Inline Configuration:** Fewer connection points, which fits two kits instead of just one in a jumbo valve box. Also provides more access for maintenance and components.

OPERATING RANGE

Flow Range: 15 to 62 gpm (56.8 l/min to 234.69 l/min)

Inlet Pressure: 15 to 115 psi (1.03 to 7.9 bar)

Regulated Pressure: 40 psi (2.8 bar)

Filtration: 120 mesh (130 micron)

Water Temperature: 33° F up to 110° F (0.5° C to 43° C)

Ambient Temperature: 33° F up to 125° F (0.5° C to 52° C)

SPECIFICATIONS

Dimensions

XCZ-150-LCS: 20 3/4" L x 5 3/4" W x 9 1/2" H

XCZ-150-LCDR: 23 1/2" L x 5 3/4" W x 9 1/2" H

Filtration

XCZ-150-LCS: 1 1/2" (3.81 cm) Stainless Steel Screen Filter, 120 Mesh (130 Micron);

Surface Area: 42 in² (270 cm²)

XCZ-150-LCDR: 1 1/2" (3.81 cm) Disc Filter, 120 Mesh (130 Micron);

Surface Area: 48 in² (310 cm²)

Valve Type

XCZ-150-LCS: 1.5" PEB

XCZ-150-LCDR: 1.5" PESB-R

Power: 24 VAC 50/60 Hz (cycles/sec) solenoid

Inrush Current: 0.41A (9.84 VA) at 50/60Hz;

Holding Current: 0.14A (3.43VA) at 50/60Hz

Coil Resistance: 30-39 Ohms

Two-wire compatible with ESP-LXD Decoders

Models

XCZ-150-LCS

XCZ-150-LCDR

Replacement Filters

Disc: LGFC120MD

Screen: LGFC120MS

U.S. Performance Data

PRESSURE LOSS CHARACTERISTICS		
Flow Rate (gpm)	XCZ-150-LCS	XCZ-150-LCDR
15	1.9	2.3
20	2.4	3.4
25	4.1	4.9
30	5.3	5.3
40	7.4	8.0
50	13.6	14.4
60	20.7	20.7

Metric Performance Data

PRESSURE LOSS CHARACTERISTICS		
Flow Rate (l/h)	XCZ-150-LCS	XCZ-150-LCDR
56.8	0.13	0.16
75.7	0.17	0.23
94.7	0.28	0.34
113.6	0.37	0.37
151.4	0.51	0.55
189.3	0.94	0.99
227.1	1.43	1.43



XCZ-150-LCS



XCZ-150-LCDR

Large-Capacity Filters

FEATURES

- Provides extra large filtration capacity for residential, commercial and municipal applications.
- Durable filters can be easily removed for cleaning. Disc filters can decompress for easy cleaning.
- Auxiliary connection with a threaded cap can be drilled to allow draining or depressurization.

OPERATING RANGE

1" Model:

Maximum Flow: Up to 26 gpm (6 m³/hr)
Disc Filtering Surface: 28 in² (180 cm²)

1.5" Model:

Maximum Flow: Up to 62 gpm (14 m³/hr)
Disc Filtering Surface: 48 in² (310 cm²)
Screen Filtering Surface: 42 in² (270 cm²)

2" Model:

Maximum Flow: Up to 110 gpm (25 m³/hr)
Disc Filtering Surface: 81 in² (525 cm²)
Screen Filtering Surface: 75 in² (485 cm²)

Maximum Pressure: 116 psi (8 bar)

Maximum Temperature: 140° F (60° C)

MODELS

LCRBY100D: 1" Large-Capacity Disc Filter

LCRBY150S: 1.5" Large-Capacity Screen Filter

LCRBY150D: 1.5" Large-Capacity Disc Filter

LCRBY200S: 2" Large-Capacity Screen Filter

LCRBY200D: 2" Large-Capacity Disc Filter

Replacement Filters:

LGFC120MS: 1.5" – 2" Screen Filter

LGFC120MD: 1.5" – 2" Disc Filter

SPECIFICATIONS

Inlet/Outlet Size:

1" Models: 1" NPT

1.5" Models: 1.5" NPT

2" Models: 2" NPT

FILTRATION

Stainless Steel Screen Filter: 120 mesh (130 micron)*

Plastic Filter Discs: 120 mesh (130 micron)

*Screen not available in 1" model.

NOTE: Filter should be installed downstream of valve.



Disc Filter Pressure Loss Characteristics

Flow Rate		1" Filter		1.5" Filter		2" Filter	
gpm	l/m	psi	bar	psi	bar	psi	bar
5	18.93	0.60	0.04	0.08	0.01	0.10	0.01
11	41.67	1.16	0.08	0.18	0.01	0.10	0.01
22	83.33	2.61	0.18	0.40	0.03	0.10	0.01
33	125.00	4.35	0.30	0.73	0.05	0.24	0.02
44	166.67	—	—	1.05	0.07	0.40	0.03
55	208.33	—	—	1.50	0.10	0.60	0.04
66	250.00	—	—	2.18	0.15	0.82	0.06
77	291.67	—	—	3.10	0.21	1.10	0.08
88	333.33	—	—	3.95	0.27	1.60	0.11
99	375.00	—	—	—	—	2.03	0.14
110	416.67	—	—	—	—	2.47	0.17



Plastic Filter Discs:

These filters are made up of over a hundred grooved discs that allow water to pass while trapping debris. Less maintenance required due to large surface area.

Screen Filter Pressure Loss Characteristics

Flow Rate		1" Filter		1.5" Filter		2" Filter	
gpm	l/m	psi	bar	psi	bar	psi	bar
5	18.93	0.80	0.06	0.00	0.00	0.00	0.00
11	41.67	1.74	0.12	0.00	0.00	0.00	0.00
22	83.33	2.90	0.20	0.50	0.03	0.20	0.01
33	125.00	4.06	0.28	0.95	0.07	0.25	0.02
44	166.67	—	—	1.45	0.10	0.44	0.03
55	208.33	—	—	1.89	0.13	0.60	0.04
66	250.00	—	—	2.32	0.16	0.87	0.06
77	291.67	—	—	2.76	0.19	1.16	0.08
88	333.33	—	—	3.19	0.22	1.45	0.10
99	375.00	—	—	—	—	1.89	0.13
110	416.67	—	—	—	—	2.32	0.16



Screen Filter:

The 120 mesh screen filters are easy to clean and provide reliable filtration.

NOTE: Filter should be installed downstream of the valve to prevent the filter from being under constant pressure.

Filter Housing Dimensions

Model	A, B	H	W	X	D
1" (2.5 cm)	1" NPT	6.81" (17.3 cm)	7.48" (19.0 cm)	6.22" (15.8 cm)	3.27" (8.3 cm)
1.5" (3.8cm)	1.5" NPT	9.53" (24.2 cm)	10.25" (26.0 cm)	9.92" (25.2 cm)	5.67" (14.4 cm)
2" (5.1 cm)	2" NPT	9.76 (24.8 cm)	10.63" (27.0 cm)	10.51" (26.7 cm)	5.67" (14.4 cm)

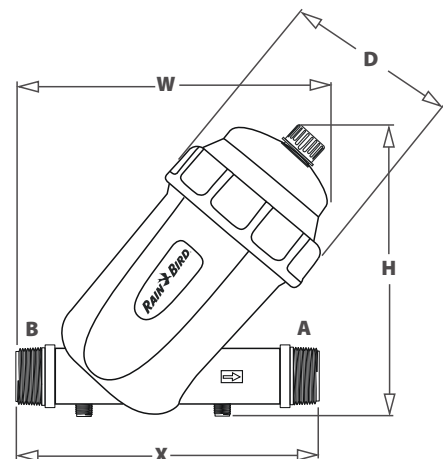

ESP-9V Battery-Operated Controller

FEATURES

Controller Features

- Waterproof case ensures long life, even when installed in a valve box.
- Common programming features are easily accessed on one screen, making programming quick and easy.
- Operates for approximately one full year using one 9-volt alkaline battery, or two years with two 9-volt alkaline batteries.
- Large LCD display with easy to navigate user interface.
- Sensor input with bypass override.
- Mast valve/pump-start circuit (multi-zone units only).
- Non-volatile (100-year) program memory.
- IP68 certified for protection against dust and water intrusion.
- Plastic controller case has outstanding resistance to weather, yellowing and aging.

Scheduling Features

- Dedicated manual watering button for easy operation.
- Automatic zone-stacking ensures that only one valve irrigates at the same time. ESP-9V will automatically irrigate the lower number zone first if zones are scheduled to water at the same time.
- Contractor Rapid Programming™ automatically copies the start times and watering days from zone 1 to all remaining zones at initial setup.
- Run times, start times, and watering days are customizable by zone.
- 6 start times per zone.
- 4 watering day options per zone: Custom days of the week, Cyclic, and ODD or EVEN calendar days.
- Delay watering (1 to 9 days).

VALVE COMPATIBILITY

- Rain Bird K80920, Hunter 458200, Irritrol DCL, Toro DCLS-P

MODELS

ESP9V1: 1-Zone ESP-9V Controller

ESP9V2: 2-Zone ESP-9V Controller

ESP9V4: 4-Zone ESP-9V Controller

ESP9V6: 6-Zone ESP-9V Controller

ESP9V1SOL: 1-Zone + 9V Solenoid

ESP9VDVKIT: 1-Zone + 1" DV Valve (SLIP)

9VMOUNT: Wall-mount kit

SPECIFICATIONS

Dimensions:

Width: 5.35" (13.59 cm)

Height: 4.04" (10.26 cm)

Depth: 2.42" (6.15 cm)

Weight: 2.0 lbs (907 g)

LCD Screen Dimensions:

Width: 2.25" (5.72 cm)

Height: 1.25" (3.18 cm)

Optional Wall Mount Dimensions:

Width: 4.25" (10.76 cm)

Height: 6.93" (17.60 cm)

Depth: 1.97" (4.99 cm)

Weight: 3.6 oz (107 g)

CERTIFICATIONS

- cULus, FCC, IC, CE, RCM, IP68, RoHS, WEEE



Optional Wall Mount



TBOS Battery-Operated Controller



FEATURES

Controller Features

- Operates for approximately one full year using one 9-volt alkaline battery.
- Completely potted to obtain IP68 conformity.
- Independent station operation allows sequential start times (with stacking in case of overlap) restriction compliance.
- Master valve output (on TBOS-II 2, 4, and 6 Control Modules).
- No loss of irrigation program after a battery replacement.
- Backward-compatible with the TBOS-II Field Transmitter.

Rain Bird App Features

- Create, review and transmit irrigation programs.
- Capability to set zones or programs to manually irrigate.
- Basic programming includes 3 independent programs A,B and C, each with 8 start times per day.
- Stations can be assigned to several programs with different watering run times.
- Run time is from 1 minute to 12 hours in 1-minute increments.
- Five watering day cycle modes (Custom, even, odd, odd-31, cyclical) selectable by program for maximum flexibility and watering.
- Program and global Monthly Seasonal Adjust; 0% to 300% (1% increments).
- Built-in ID with naming capability. The control module and stations can be individually named.
- Optional passcode.
- Delay watering from 1 to 14 days.
- Permanently turn the controller off to prevent irrigation.
- Battery indicator reports the status of the control module's battery.
- Capability to clear the control module's irrigation program.

VALVE COMPATIBILITY

- Rain Bird TBOS Potted Latching Solenoid (K80920)
 - DV, DVF, ASF, PGA, PEB, PESB, GB, EFB-CP, BPE and BPES series
- Hunter 458200, Irritrol DCL, Toro DCLS-P

MODELS

INFRARED PORT

TBOS-BT1*: 1 Station

TBOS-BT2*: 2 Station

TBOS-BT4*: 4 Stations

TBOS-BT6*: 6 Stations

*Only available in Europe

NO INFRARED PORT

TBOS-BT1LT: 1 Station

TBOS-BT2LT: 2 Stations

TBOS-BT4LT: 4 Stations

TBOS-BT6LT*: 6 Stations

SPECIFICATIONS

Dimensions:

Width: 3.8" (9.5 cm)

Height: 5.1" (13.0 cm)

Depth: 2.0" (5.3 cm)

Weight: 17.6 oz (500 g)

Rain Bird App (TBOS-BT): Available for Android and IOS devices

ACCESSORIES

- TBOS Potted Latching Solenoid
- RSD Series Rain Sensors
- The TBOS solenoid adapters will adapt the potted latching solenoid for use in retrofit applications with selected Irritrol® (Hardie/Richdel) and Buckner® valves or Champion® and Superior® valve actuators

CERTIFICATIONS

- cULus, CE, RoHS, WEEE, FCC



Areas

6,452 sq cm	1 sq in
144 sq in	1 sq ft
9 sq ft	1 sq yd
43,560 sq ft	1 acre
1 acre	43,560 sq ft
1 acre	4,840 sq yd
1 acre	160 sq rods
1 sq rod	272.25 sq ft
1 sq rod	30.25 sq yd
640 acres	1 sq mi
640 acres	1 section
Area of a Circle	$r^2 \times 3.1416$
Area of a Square	One Side Squared
Area of a Triangle	$\frac{1}{2}$ Base x Altitude
Area of a Rectangle	Length x Width
Area of a Parallelogram	Base x Altitude

Lineal Measurements

1 centimeter	0.3937 inches
1 cubit	18 inches
1 meter	39.37 inches
1 rod	16.5 feet
1 rod	5.5 yards
1 chain	4 rods
1 chain	66 feet
320 rods	1 mile
5280 feet	1 mile
Circumference of Circle	Diameter x 3.1416

Volume

1728 cu in	1 cu ft
231 cu in	1 gallon
27 cu ft	1 cu yd
1 cu ft	7.48052 gal (U.S.)
1 cu yd	202 gallons (U.S.)
16 drams	1 ounce
32 ounces	1 quart
4 quarts	1 gallon
1 gallon	3.785 liters
1 gallon	0.00379 cu m
1 gallon	0.833 imperial gallons
27,154 gallons	1 acre inch
325,851 gallons	1 acre foot
1,000,000 gallons	3.0689 acre ft
1 acre foot	43,560 cu ft
Volume of a Cube	Area of Base x Height
Volume of a Pyramid	$\frac{1}{2}$ Area of Base x Height
Volume of a Sphere	$Diameter^3 \times 0.5236$

Mass/Weight

1 kg	2.204 lbs
1 lb	454 g = 7,000 grains
1 slug	14.5 kg
1 stone	14 lb

Weights

1 U.S. Gallon (Water)	8.3357 lbs
1 Cu Foot (Water)	62.3554 lbs
1 Imperial Gallon	10.0 lbs
1 Liter	2.2 lbs
Earth, in Place Undisturbed	100 lbs/cu ft
Earth, Dry and Loose	82-90 lbs/cu ft
Earth, Moist	75-100 lbs/cu ft
Sand, Dry	90-106 lbs/cu ft
Shale or Red Rock	162 lbs/cu ft
Limestone	160-163 lbs/cu ft
Base Gravel	12.0 lbs/sq ft/inch Thick in Place
Asphalt	12.5 lbs/sq ft/inch Thick in Place
Sack Cement	94 lbs
Concrete (Plain)	140 lbs/cu ft
Concrete (Reinforced)	150 lbs/cu ft

Pressures

1 atmosphere	29.921 inches of hg @ 32° F
1 atmosphere	33.94 ft of water @ 62° F
1 atmosphere	14.6963 lbs/sq in
1 lb/sq inch	2.31 feet of head
1 foot of water	0.433 lbs/sq in
1 kg/sq cm	14.22 lbs/sq in
1 foot of water	62.3554 lbs/sq ft
1 bar	14.5 lbs/sq in

Flows

1 gallon/min (U.S.)	0.002228 cu ft/sec
1 gallon/min (U.S.)	0.13368 cu ft/min
1 gallon/min (U.S.)	8.0208 cu ft/hr
1 gallon/min (U.S.)	0.06309 liters/sec
1 gallon/min (U.S.)	3.78533 liters/min
1 gallon/min (U.S.)	0.0044192 acre ft/24 hrs
1 gallon/min (U.S.)	0.22712 cu m/hr
1 cu ft/sec	448.83 gpm
1 liter/sec	15.85 gpm
1 cu m/min	264 gpm
1 acre in/hr	452.57 gpm
1 acre ft/day	226.3 gpm
1,000,000 gallons/day	694.4 gpm
1 cu ft/sec	0.992 acre in/hr

Power

1 horsepower	33,000 ft lbs/min
1 horsepower	746 watts
1 horsepower	0.746 kilowatts

Temperature

F	$^{\circ}\text{C} \times 9/5 + 32$
C	$(^{\circ}\text{F} - 32) \times 5/9$

Design Formulas

Precipitation Rate (in/hr)	<i>S</i> = Spacing	Run-Time	Velocity
Square = $\frac{96.3 \times \text{GPM} \times 360}{S \times S \times \text{Sprinkler Arc}}$		Run-Time = $\frac{\text{Desired Application} \times 60}{\text{Precipitation Rate}}$	$V = \frac{0.480 \times Q}{(ID)^2}$
Triangular = $\frac{96.3 \times \text{GPM} \times 360}{S \times S \times 0.866 \times \text{Sprinkler Arc}}$			Where: V = Velocity in feet per second Q = Gallons per minute ID = Inside diameter of pipe
Single Row = $\frac{96.3 \times \text{GPM}}{S \times 0.8 \text{ Diameter}}$			

Power Formulas

Horse Power	Electrical Power	Pump Laws (Affinity Laws)
1 hp = 550 foot pounds per second = 746 watts or 0.746 kW = 1 second foot of water falling 8.8'	3φ kVA = $\frac{1.732 \times \text{FLA} \times \text{Voltage}}{1000}$ 1φ kVA = $\frac{\text{FLA} \times \text{Voltage}}{1000}$	$\text{RPM}_2 / \text{RPM}_1 = \text{Flow}_2 / \text{Flow}_1$ $(\text{RPM}_2 / \text{RPM}_1)^2 = \text{Pressure}_2 / \text{Pressure}_1$ $(\text{RPM}_2 / \text{RPM}_1)^3 = \text{Power}_2 / \text{Power}_1$
Water HP = $\frac{\text{GPM} \times \text{TDH}}{3960}$ Where: GPM = Gallons per minute TDH = Total dynamic head	Ohm's Law: V = IR Where: V = Voltage in Volts I = Current in Amperes R = Resistance in ohms	Example: An irrigation pump operating at 1800 RPM and producing 600 gpm at 120 psi is switched to 3600 RPM: $\text{RPM}_2 / \text{RPM}_1 = \text{Flow}_2 / \text{Flow}_1$ $= 3600 \text{ RPM} / 1800 \text{ RPM}$ $= \text{Flow}_2 / 600 \text{ gpm} = 1200 \text{ gpm}$
Brake HP = $\frac{\text{GPM} \times \text{TDH}}{3960 \times E}$ Where: GPM = Gallons per minute TDH = Total dynamic head E = Pump efficiency	Amp Calculation Amps = Watts / Volts	$(\text{RPM}_2 / \text{RPM}_1)^2 = \text{Pressure}_2 / \text{Pressure}_1$ $= (3600 \text{ RPM} / 1800 \text{ RPM})^2$ $= \text{Pressure}_2 / 120 \text{ psi} = 480 \text{ psi}$
1 kilowatt (kW) = 1,000 watts = 1,341 HP = 735.5 foot pounds per second		$(\text{RPM}_2 / \text{RPM}_1)^3 = \text{Power}_2 / \text{Power}_1$ $= (3600 \text{ RPM} / 1800 \text{ RPM})^3$ $= \text{Power}_2 / 60 \text{ HP} = 480 \text{ HP}$

APPENDIX

Electric Formulas for Calculating Amperes, Horsepower, Kilowatts and kVA

ALTERNATING CURRENT			
To Find:	Single Phase	Two Phase-Four Phase Wire	Three Phase
Amperes when "HP" is known	$\frac{\text{HP} \times 746}{E \times \% \text{EFF} \times \text{PF}}$	$\frac{\text{HP} \times 746}{E \times \% \text{EFF} \times \text{PF} \times 2}$	$\frac{\text{HP} \times 746}{E \times \% \text{EFF} \times \text{PF} \times 1.73}$
Amperes when "kW" is known	$\frac{\text{kW} \times 1000}{E \times \text{PF}}$	$\frac{\text{kW} \times 1000}{E \times \text{PF} \times 2}$	$\frac{\text{kW} \times 1000}{E \times \text{PF} \times 1.73}$
Amperes when "kVa" is known	$\frac{\text{kVA} \times 1000}{E}$	$\frac{\text{kVA} \times 1000}{E \times 2}$	$\frac{\text{kVA} \times 1000}{E \times 1.73}$
Kilowatts	$\frac{E \times I \times \text{PF}}{1000}$	$\frac{E \times I \times \text{PF} \times 2}{1000}$	$\frac{E \times I \times \text{PF} \times 1.73}{1000}$
Kilovolt-Amperes "kVA"	$\frac{E \times I}{1000}$	$\frac{E \times I \times 2}{1000}$	$\frac{E \times I \times 1.73}{1000}$
Horsepower	$\frac{E \times I \times \% \text{EFF} \times \text{PF}}{746}$	$\frac{E \times I \times \% \text{EFF} \times \text{PF} \times 2}{746}$	$\frac{E \times I \times \% \text{EFF} \times \text{PF} \times 1.73}{746}$

Where:

Power Factor (PF) = $\frac{\text{Power Used (Watts)}}{\text{Apparent Power}}$ or $\frac{\text{kW}}{\text{kVA}}$

Power Efficiency (%EFF) = $\frac{\text{Output (Watts)}}{\text{Input (Watts)}}$

E = Volts
I = Amperes
W = Watts

Conductor Properties For Insulated Annealed Copper Direct Current Resistance

OHMS PER 1,000 FEET					
Copper Awg	Temperature				Cross Sectional Area Circular Mils
	167° F (75° C)	149° F (65° C)	77° F (25° C)	68° F (20° C)	
18 Solid	7.77	7.519	6.515	6.390	1,620
18 Stranded	7.95	7.693	6.666	6.538	1,620
16 Solid	4.89	4.732	4.100	4.021	2,580
16 Stranded	4.99	4.829	4.184	4.104	2,580
14 Solid	3.07	2.971	2.574	2.525	4,110
14 Stranded	3.14	3.039	2.633	2.582	4,110
12 Solid	1.93	1.868	1.618	1.587	6,530
12 Stranded	1.98	1.916	1.660	1.628	6,530
10 Solid	1.21	1.171	1.015	0.995	10,380
10 Stranded	1.24	1.200	1.040	1.020	10,380
8 Solid	0.764	0.739	0.641	0.628	16,510
8 Stranded	0.778	0.753	0.652	0.640	16,510
6 Stranded	0.491	0.475	0.412	0.404	26,240
4 Stranded	0.308	0.298	0.258	0.253	41,740
2 Stranded	0.194	0.188	0.163	0.160	66,360
1/0 Stranded	0.122	0.118	0.102	0.100	105,600
2/0 Stranded	0.097	0.094	0.081	0.080	133,100

Source: 2008 Edition of *National Electric Code* (NFPA 70), Chapter 9, Table 8.
System designer must use resistance values which correlate to temperatures and applications for each specific project.

Full Load Amperage (FLA)

Motor HP	Single Phase A-C		Three Phase A-C Induction Type Squirrel Cage & Wound Rotor		
	115 VOLTS	230 VOLTS*	230 VOLTS*	460 VOLTS	575 VOLTS
½	9.8	4.9	2.2	1.1	0.9
¾	13.8	6.9	3.2	1.6	1.3
1	16	8	4.2	2.1	1.7
1½	20	10	6.0	3.0	2.4
2	24	12	6.8	3.4	2.7
3	34	17	9.6	4.8	3.9
5	56	28	15.2	7.6	6.1
7½	80	40	22	11	9
10	100	50	28	14	11
15	—	—	42	21	17
20	—	—	54	27	22
25	—	—	68	34	27
30	—	—	80	40	32
40	—	—	104	52	41
50	—	—	130	65	52
60	—	—	154	77	62
75	—	—	192	96	77
100	—	—	240	120	96
125	—	—	296	148	118
150	—	—	350	175	140
200	—	—	456	228	182
250	—	—	558	279	223

*For 208V applications, increase the 230V FLA by 10%.

Horsepower to Kilowatts

Horsepower	Kilowatt
1	0.746
3	2.2
5	3.7
10	7.5
15	11.2
20	14.9
25	18.7
30	22.4
40	29.8
50	37.3
60	44.8
75	56.0

Pressure Conversion

psi	Feet	Meter	Bar	kPa
1	2.3090	0.7038	0.0689	6.8948
80	185	56	5.5	552
85	196	60	5.9	586
90	208	63	6.2	621
95	219	67	6.6	655
100	231	70	6.9	689
105	242	74	7.2	724
110	254	77	7.6	758
115	266	81	7.9	793
120	277	84	8.3	827
125	289	88	8.6	862
130	300	91	9.0	896
135	312	95	9.3	931
140	323	99	9.7	965
150	346	106	10.3	1034
160	369	113	11.0	1103
170	393	120	11.7	1172
180	416	127	12.4	1241
190	439	134	13.1	1310
200	462	141	13.8	1379

Flow Rate Conversion

gpm	ft ³ /s	m ³ /h	l/s	acre-ft/day
1	0.0022	0.2271	0.0002	0.004419
100	0.22	22.7	6.3	0.442
250	0.56	56.8	15.8	1.105
500	1.11	113.6	31.5	2.210
750	1.67	170.3	47.3	3.314
1000	2.23	227.1	63.1	4.419
1500	3.34	340.7	94.6	6.629
2000	4.46	454.2	126.2	8.838
2500	5.57	567.8	157.7	11.048
3000	6.68	681.4	189.3	13.258
3500	7.80	794.9	220.8	15.467
4000	8.91	908.5	252.4	17.677
4500	10.03	1022.1	283.9	19.886
5000	11.14	1135.6	315.5	22.096
6000	13.37	1362.7	378.5	26.515
7000	15.60	1589.9	441.6	30.934
8000	17.82	1817.0	504.7	35.353
9000	20.05	2044.1	567.8	39.773
10000	22.28	2271.2	630.9	44.192

Lake Intake Box Screen Sizing

Flow Rate In (gpm)	Box Screen Size
0 - 500	18" square
501 - 1000	24" square
1001 - 1800	30" square
1801 - 2800	36" square
2801 - 4000	42" square
4001 - 5000	48" square
5001 - 7000	54" square
7001 - 8500	60" square
8501 - 10000	66" square

Based on screen velocities of less than 0.5 feet per second.

Micron to Mesh Conversion

Micron	U.S. Mesh	Inches
2000	10	0.0787
1680	12	0.0661
1410	14	0.0555
1190	16	0.0469
1000	18	0.0394
841	20	0.0331
707	25	0.028
595	30	0.0232
500	35	0.0197
420	40	0.0165
354	45	0.0138
297	50	0.0117
250	60	0.0098
210	70	0.0083
177	80	0.007
149	100	0.0059
125	120	0.0049
105	140	0.0041
88	170	0.0035
74	200	0.0029
63	230	0.0024
53	270	0.0021
44	325	0.0017
37	400	0.0015

Wet Well Intake Pipe Sizing

Flow Rate In gpm	Length of Pipe in Feet			
	50'	100'	200'	300'
0 - 500	12"	12"	12"	14"
501 - 1000	18"	18"	18"	18"
1001 - 1500	24"	24"	24"	24"
1501 - 2000	26"	26"	26"	26"
2001 - 2500	28"	28"	28"	28"
2501 - 3000	30"	30"	30"	30"
3001 - 3500	32"	32"	32"	32"
3501 - 4000	34"	34"	34"	34"
4001 - 5000	36"	36"	36"	36"

The nominal IPS pipe diameters listed in this chart assume a total equivalent pipe length as listed for friction loss calculations. A recommended internal pipe water velocity of up to 1.5 feet per second and/or a draw down of 1 inch or less is used to develop this conservative intake sizing table. Consult a Rain Bird engineer for values ranging outside of this chart.

Wet Well Open Area Sizing

Size	Shape	Number of Pumps
36"	Round	1 – Vertical Turbine
48"	Round	1 or 2 – Vertical Turbines
60"	Round	1 or 2 – Vertical Turbines
72"	Round	1 to 3 – Vertical Turbines
84"	Round	1 to 5 – Vertical Turbines
96"	Round	1 to 6 – Vertical Turbines
6' x 8'	Rectangular	1 to 7 – Vertical Turbines

PE 4710 IPS HDPE DR 13.5 (161 psi) Pipe

VELOCITY IN FEET PER SECOND — FRICTION LOSS IN PSI PER 100 FEET (C = 150)																				
Nominal Size (ID) Flow (gpm)	2" (2.002)		3" (2.950)		4" (3.793)		6" (5.585)		8" (7.271)		10" (9.062)		12" (10.748)		14" (11.801)		16" (13.487)		18" (15.173)	
	Vel	Loss	Vel	Loss	Vel	Loss	Vel	Loss	Vel	Loss	Vel	Loss	Vel	Loss	Vel	Loss	Vel	Loss	Vel	Loss
2	0.20	0.01	0.09	0.00	0.06	0.00	0.00	0.00	0.00	0.00	0.00	0.00	0.00	0.00	0.00	0.00	0.00	0.00	0.00	0.00
4	0.41	0.02	0.19	0.00	0.11	0.00	0.00	0.00	0.00	0.00	0.00	0.00	0.00	0.00	0.00	0.00	0.00	0.00	0.00	0.00
6	0.61	0.04	0.28	0.01	0.17	0.00	0.00	0.00	0.00	0.00	0.00	0.00	0.00	0.00	0.00	0.00	0.00	0.00	0.00	0.00
8	0.81	0.07	0.38	0.01	0.23	0.00	0.00	0.00	0.00	0.00	0.00	0.00	0.00	0.00	0.00	0.00	0.00	0.00	0.00	0.00
10	1.02	0.10	0.47	0.02	0.28	0.00	0.00	0.00	0.00	0.00	0.00	0.00	0.00	0.00	0.00	0.00	0.00	0.00	0.00	0.00
12	1.22	0.14	0.56	0.02	0.34	0.01	0.00	0.00	0.00	0.00	0.00	0.00	0.00	0.00	0.00	0.00	0.00	0.00	0.00	0.00
14	1.43	0.19	0.66	0.03	0.40	0.01	0.00	0.00	0.00	0.00	0.00	0.00	0.00	0.00	0.00	0.00	0.00	0.00	0.00	0.00
16	1.63	0.25	0.75	0.04	0.45	0.01	0.00	0.00	0.00	0.00	0.00	0.00	0.00	0.00	0.00	0.00	0.00	0.00	0.00	0.00
18	1.83	0.31	0.84	0.05	0.51	0.01	0.00	0.00	0.00	0.00	0.00	0.00	0.00	0.00	0.00	0.00	0.00	0.00	0.00	0.00
20	2.04	0.37	0.94	0.06	0.57	0.02	0.00	0.00	0.00	0.00	0.00	0.00	0.00	0.00	0.00	0.00	0.00	0.00	0.00	0.00
22	2.24	0.44	1.03	0.07	0.62	0.02	0.00	0.00	0.00	0.00	0.00	0.00	0.00	0.00	0.00	0.00	0.00	0.00	0.00	0.00
24	2.44	0.52	1.13	0.08	0.68	0.02	0.00	0.00	0.00	0.00	0.00	0.00	0.00	0.00	0.00	0.00	0.00	0.00	0.00	0.00
26	2.65	0.61	1.22	0.09	0.74	0.03	0.00	0.00	0.00	0.00	0.00	0.00	0.00	0.00	0.00	0.00	0.00	0.00	0.00	0.00
28	2.85	0.70	1.31	0.11	0.79	0.03	0.00	0.00	0.00	0.00	0.00	0.00	0.00	0.00	0.00	0.00	0.00	0.00	0.00	0.00
30	3.05	0.79	1.41	0.12	0.85	0.04	0.00	0.00	0.00	0.00	0.00	0.00	0.00	0.00	0.00	0.00	0.00	0.00	0.00	0.00
35	3.56	1.05	1.64	0.16	0.99	0.05	0.00	0.00	0.00	0.00	0.00	0.00	0.00	0.00	0.00	0.00	0.00	0.00	0.00	0.00
40	4.07	1.35	1.88	0.20	1.13	0.06	0.00	0.00	0.00	0.00	0.00	0.00	0.00	0.00	0.00	0.00	0.00	0.00	0.00	0.00
45	4.58	1.67	2.11	0.25	1.28	0.07	0.00	0.00	0.00	0.00	0.00	0.00	0.00	0.00	0.00	0.00	0.00	0.00	0.00	0.00
50	5.09	2.04	2.34	0.31	1.42	0.09	0.00	0.00	0.00	0.00	0.00	0.00	0.00	0.00	0.00	0.00	0.00	0.00	0.00	0.00
55	5.60	2.43	2.58	0.37	1.56	0.11	0.00	0.00	0.00	0.00	0.00	0.00	0.00	0.00	0.00	0.00	0.00	0.00	0.00	0.00
60	6.11	2.85	2.81	0.43	1.70	0.13	0.00	0.00	0.00	0.00	0.00	0.00	0.00	0.00	0.00	0.00	0.00	0.00	0.00	0.00
65	6.62	3.31	3.05	0.50	1.84	0.15	0.00	0.00	0.00	0.00	0.00	0.00	0.00	0.00	0.00	0.00	0.00	0.00	0.00	0.00
70	7.13	3.80	3.28	0.58	1.99	0.17	0.00	0.00	0.00	0.00	0.00	0.00	0.00	0.00	0.00	0.00	0.00	0.00	0.00	0.00
75	7.63	4.31	3.52	0.65	2.13	0.19	0.00	0.00	0.00	0.00	0.00	0.00	0.00	0.00	0.00	0.00	0.00	0.00	0.00	0.00
80	8.14	4.86	3.75	0.74	2.27	0.22	0.00	0.00	0.00	0.00	0.00	0.00	0.00	0.00	0.00	0.00	0.00	0.00	0.00	0.00
85	8.65	5.44	3.99	0.82	2.41	0.24	0.00	0.00	0.00	0.00	0.00	0.00	0.00	0.00	0.00	0.00	0.00	0.00	0.00	0.00
90	9.16	6.04	4.22	0.92	2.55	0.27	0.00	0.00	0.00	0.00	0.00	0.00	0.00	0.00	0.00	0.00	0.00	0.00	0.00	0.00
100			4.69	1.11	2.84	0.33	1.31	0.05	0.77	0.01	0.50	0.00	0.35	0.00	0.00	0.00	0.00	0.00	0.00	0.00
110			5.16	1.33	3.12	0.39	1.44	0.06	0.85	0.02	0.55	0.01	0.39	0.00	0.00	0.00	0.00	0.00	0.00	0.00
120			5.63	1.56	3.40	0.46	1.57	0.07	0.93	0.02	0.60	0.01	0.42	0.00	0.00	0.00	0.00	0.00	0.00	0.00
130			6.09	1.81	3.69	0.53	1.70	0.08	1.00	0.02	0.65	0.01	0.46	0.00	0.00	0.00	0.00	0.00	0.00	0.00
140			6.56	2.08	3.97	0.61	1.83	0.09	1.08	0.03	0.70	0.01	0.49	0.00	0.00	0.00	0.00	0.00	0.00	0.00
150			7.03	2.36	4.25	0.69	1.96	0.11	1.16	0.03	0.75	0.01	0.53	0.00	0.00	0.00	0.00	0.00	0.00	0.00
160			7.50	2.66	4.54	0.78	2.09	0.12	1.23	0.03	0.79	0.01	0.57	0.00	0.00	0.00	0.00	0.00	0.00	0.00
170			7.97	2.98	4.82	0.88	2.22	0.13	1.31	0.04	0.84	0.01	0.60	0.01	0.00	0.00	0.00	0.00	0.00	0.00
180			8.44	3.31	5.10	0.97	2.35	0.15	1.39	0.04	0.89	0.01	0.64	0.01	0.00	0.00	0.00	0.00	0.00	0.00
190			8.91	3.66	5.39	1.08	2.49	0.16	1.47	0.05	0.94	0.02	0.67	0.01	0.00	0.00	0.00	0.00	0.00	0.00
200			9.38	4.02	5.67	1.18	2.62	0.18	1.54	0.05	0.99	0.02	0.71	0.01	0.00	0.00	0.00	0.00	0.00	0.00
225			10.55	5.00	6.38	1.47	2.94	0.22	1.74	0.06	1.12	0.02	0.79	0.01	0.00	0.00	0.00	0.00	0.00	0.00
250			11.72	6.08	7.09	1.79	3.27	0.27	1.93	0.08	1.24	0.03	0.88	0.01	0.00	0.00	0.00	0.00	0.00	0.00
275			12.89	7.25	7.80	2.13	3.60	0.32	2.12	0.09	1.37	0.03	0.97	0.01	0.00	0.00	0.00	0.00	0.00	0.00
300			14.06	8.52	8.51	2.51	3.92	0.38	2.32	0.11	1.49	0.04	1.06	0.02	0.00	0.00	0.00	0.00	0.00	0.00

■ Use caution at shaded velocities.

Continued on next page →

← Continued from previous page

PE 4710 IPS HDPE DR 13.5 (161 psi) Pipe

VELOCITY IN FEET PER SECOND — FRICTION LOSS IN PSI PER 100 FEET (C = 150)																				
Nominal Size (ID) Flow (gpm)	2" (2.002)		3" (2.950)		4" (3.793)		6" (5.585)		8" (7.271)		10" (9.062)		12" (10.748)		14" (11.801)		16" (13.487)		18" (15.173)	
	Vel	Loss	Vel	Loss	Vel	Loss	Vel	Loss	Vel	Loss	Vel	Loss	Vel	Loss	Vel	Loss	Vel	Loss	Vel	Loss
325			15.24	9.88	9.22	2.91	4.25	0.44	2.51	0.12	1.61	0.04	1.15	0.02	0.00	0.00	0.00	0.00	0.00	0.00
350			16.41	11.34	9.93	3.34	4.58	0.51	2.70	0.14	1.74	0.05	1.24	0.02	0.00	0.00	0.00	0.00	0.00	0.00
375				12.88	10.63	3.79	4.91	0.58	2.89	0.16	1.86	0.05	1.32	0.02	0.00	0.00	0.00	0.00	0.00	0.00
400				14.52	11.34	4.27	5.23	0.65	3.09	0.18	1.99	0.06	1.41	0.03	0.00	0.00	0.00	0.00	0.00	0.00
425				16.24	12.05	4.78	5.56	0.73	3.28	0.20	2.11	0.07	1.50	0.03	0.00	0.00	0.00	0.00	0.00	0.00
450				18.06	12.76	5.31	5.89	0.81	3.47	0.22	2.24	0.08	1.59	0.03	0.00	0.00	0.00	0.00	0.00	0.00
475				19.96	13.47	5.87	6.21	0.89	3.67	0.25	2.36	0.08	1.68	0.04	0.00	0.00	0.00	0.00	0.00	0.00
500					14.18	6.46	6.54	0.98	3.86	0.27	2.48	0.09	1.77	0.04	0.00	0.00	0.00	0.00	0.00	0.00
550					15.60	7.71	7.19	1.17	4.24	0.32	2.73	0.11	1.94	0.05	0.00	0.00	0.00	0.00	0.00	0.00
600					17.02	9.05	7.85	1.38	4.63	0.38	2.98	0.13	2.12	0.06	0.00	0.00	0.00	0.00	0.00	0.00
650					18.43	10.50	8.50	1.60	5.02	0.44	3.23	0.15	2.30	0.07	0.00	0.00	0.00	0.00	0.00	0.00
700					19.85	12.05	9.16	1.83	5.40	0.51	3.48	0.17	2.47	0.08	0.00	0.00	0.00	0.00	0.00	0.00
750					21.27	13.69	9.81	2.08	5.79	0.58	3.73	0.20	2.65	0.09	0.00	0.00	0.00	0.00	0.00	0.00
800									6.17	0.65	3.97	0.22	2.83	0.10	2.34	0.06	1.79	0.03	1.42	0.02
850									6.56	0.73	4.22	0.25	3.00	0.11	2.49	0.07	1.91	0.04	1.51	0.02
900									6.95	0.81	4.47	0.28	3.18	0.12	2.64	0.08	2.02	0.04	1.59	0.02
950									7.33	0.89	4.72	0.31	3.36	0.13	2.78	0.08	2.13	0.04	1.68	0.02
1000									7.72	0.98	4.97	0.34	3.53	0.15	2.93	0.09	2.24	0.05	1.77	0.03
1050									8.10	1.08	5.22	0.37	3.71	0.16	3.08	0.10	2.36	0.05	1.86	0.03
1100									8.49	1.17	5.47	0.40	3.89	0.18	3.22	0.11	2.47	0.06	1.95	0.03
1150									8.88	1.27	5.71	0.44	4.06	0.19	3.37	0.12	2.58	0.06	2.04	0.04
1200									9.26	1.38	5.96	0.47	4.24	0.21	3.52	0.13	2.69	0.07	2.13	0.04
1250									9.65	1.49	6.21	0.51	4.41	0.22	3.66	0.14	2.80	0.07	2.22	0.04
1300									10.03	1.60	6.46	0.55	4.59	0.24	3.81	0.15	2.92	0.08	2.30	0.04
1350									10.42	1.71	6.71	0.59	4.77	0.26	3.96	0.16	3.03	0.08	2.39	0.05
1400									10.80	1.83	6.96	0.63	4.94	0.27	4.10	0.17	3.14	0.09	2.48	0.05
1450									11.19	1.96	7.20	0.67	5.12	0.29	4.25	0.19	3.25	0.10	2.57	0.05
1500									11.58	2.08	7.45	0.71	5.30	0.31	4.39	0.20	3.36	0.10	2.66	0.06
1550											7.70	0.76	5.47	0.33	4.54	0.21	3.48	0.11	2.75	0.06
1600											7.95	0.80	5.65	0.35	4.69	0.22	3.59	0.12	2.84	0.07
1650											8.20	0.85	5.83	0.37	4.83	0.24	3.70	0.12	2.92	0.07
1700											8.45	0.90	6.00	0.39	4.98	0.25	3.81	0.13	3.01	0.07
1750											8.69	0.95	6.18	0.41	5.13	0.26	3.93	0.14	3.10	0.08
1800											8.94	1.00	6.36	0.44	5.27	0.28	4.04	0.14	3.19	0.08
1900											9.44	1.11	6.71	0.48	5.57	0.31	4.26	0.16	3.37	0.09
2000											9.94	1.22	7.06	0.53	5.86	0.34	4.49	0.18	3.54	0.10
2100											10.43	1.33	7.42	0.58	6.15	0.37	4.71	0.19	3.72	0.11
2200											10.93	1.45	7.77	0.63	6.45	0.40	4.93	0.21	3.90	0.12
2300											11.43	1.57	8.12	0.69	6.74	0.44	5.16	0.23	4.08	0.13
2400											11.92	1.70	8.48	0.74	7.03	0.47	5.38	0.25	4.25	0.14
2500											12.42	1.84	8.83	0.80	7.32	0.51	5.61	0.27	4.43	0.15

■ Use caution at shaded velocities.

SDR 21 (Class 200) PVC Pipe

VELOCITY IN FEET PER SECOND — FRICTION LOSS IN PSI PER 100 FEET (C = 150)																						
Nominal Size (ID) Flow (gpm)	1" (1.189)		1¼" (1.502)		1½" (1.720)		2" (2.149)		2½" (2.601)		3" (3.166)		4" (4.072)		6" (5.993)		8" (7.805)		10" (9.728)		12" (11.538)	
	Vel	Loss	Vel	Loss	Vel	Loss	Vel	Loss	Vel	Loss	Vel	Loss	Vel	Loss	Vel	Loss	Vel	Loss	Vel	Loss	Vel	Loss
2	0.58	0.07	0.36	0.02	0.28	0.01	0.18	0.00	0.12	0.00	0.08	0.00	0.05	0.00	0.02	0.00	0.01	0.00	0.01	0.00	0.01	0.00
4	1.15	0.24	0.72	0.08	0.55	0.04	0.35	0.01	0.24	0.01	0.16	0.00	0.10	0.00	0.05	0.00	0.03	0.00	0.02	0.00	0.01	0.00
6	1.73	0.51	1.09	0.16	0.83	0.08	0.53	0.03	0.36	0.01	0.24	0.00	0.15	0.00	0.07	0.00	0.04	0.00	0.03	0.00	0.02	0.00
8	2.31	0.86	1.45	0.28	1.10	0.14	0.71	0.05	0.48	0.02	0.33	0.01	0.20	0.00	0.09	0.00	0.05	0.00	0.03	0.00	0.02	0.00
10	2.89	1.30	1.81	0.42	1.38	0.22	0.88	0.07	0.60	0.03	0.41	0.01	0.25	0.00	0.11	0.00	0.07	0.00	0.04	0.00	0.03	0.00
12	3.46	1.83	2.17	0.59	1.65	0.30	1.06	0.10	0.72	0.04	0.49	0.02	0.30	0.00	0.14	0.00	0.08	0.00	0.05	0.00	0.04	0.00
14	4.04	2.43	2.53	0.78	1.93	0.40	1.24	0.14	0.84	0.05	0.57	0.02	0.34	0.01	0.16	0.00	0.09	0.00	0.06	0.00	0.04	0.00
16	4.62	3.11	2.89	1.00	2.21	0.52	1.41	0.17	0.96	0.07	0.65	0.03	0.39	0.01	0.18	0.00	0.11	0.00	0.07	0.00	0.05	0.00
18	5.19	3.87	3.26	1.24	2.48	0.64	1.59	0.22	1.09	0.09	0.73	0.03	0.44	0.01	0.20	0.00	0.12	0.00	0.08	0.00	0.06	0.00
20	5.77	4.71	3.62	1.51	2.76	0.78	1.77	0.26	1.21	0.10	0.81	0.04	0.49	0.01	0.23	0.00	0.13	0.00	0.09	0.00	0.06	0.00
22	6.35	5.62	3.98	1.80	3.03	0.93	1.94	0.32	1.33	0.12	0.90	0.05	0.54	0.01	0.25	0.00	0.15	0.00	0.09	0.00	0.07	0.00
24	6.93	6.60	4.34	2.12	3.31	1.09	2.12	0.37	1.45	0.15	0.98	0.06	0.59	0.02	0.27	0.00	0.16	0.00	0.10	0.00	0.07	0.00
26	7.50	7.65	4.70	2.45	3.59	1.27	2.30	0.43	1.57	0.17	1.06	0.07	0.64	0.02	0.30	0.00	0.17	0.00	0.11	0.00	0.08	0.00
28	8.08	8.78	5.06	2.82	3.86	1.46	2.47	0.49	1.69	0.19	1.14	0.07	0.69	0.02	0.32	0.00	0.19	0.00	0.12	0.00	0.09	0.00
30	8.66	9.97	5.43	3.20	4.14	1.65	2.65	0.56	1.81	0.22	1.22	0.08	0.74	0.02	0.34	0.00	0.20	0.00	0.13	0.00	0.09	0.00
35	10.10	13.27	6.33	4.26	4.83	2.20	3.09	0.74	2.11	0.29	1.42	0.11	0.86	0.03	0.40	0.01	0.23	0.00	0.15	0.00	0.11	0.00
40	11.54	16.99	7.23	5.45	5.52	2.82	3.53	0.95	2.41	0.38	1.63	0.14	0.98	0.04	0.45	0.01	0.27	0.00	0.17	0.00	0.12	0.00
45			8.14	6.78	6.21	3.51	3.98	1.19	2.71	0.47	1.83	0.18	1.11	0.05	0.51	0.01	0.30	0.00	0.19	0.00	0.14	0.00
50			9.04	8.24	6.90	4.26	4.42	1.44	3.02	0.57	2.04	0.22	1.23	0.06	0.57	0.01	0.33	0.00	0.22	0.00	0.15	0.00
55			9.95	9.83	7.59	5.08	4.86	1.72	3.32	0.68	2.24	0.26	1.35	0.08	0.62	0.01	0.37	0.00	0.24	0.00	0.17	0.00
60			10.85	11.55	8.27	5.97	5.30	2.02	3.62	0.80	2.44	0.31	1.48	0.09	0.68	0.01	0.40	0.00	0.26	0.00	0.18	0.00
65			11.76	13.39	8.96	6.93	5.74	2.34	3.92	0.93	2.65	0.36	1.60	0.10	0.74	0.02	0.44	0.00	0.28	0.00	0.20	0.00
70					9.65	7.95	6.18	2.69	4.22	1.06	2.85	0.41	1.72	0.12	0.80	0.02	0.47	0.01	0.30	0.00	0.21	0.00
75					10.34	9.03	6.63	3.05	4.52	1.21	3.05	0.46	1.85	0.14	0.85	0.02	0.50	0.01	0.32	0.00	0.23	0.00
80					11.03	10.17	7.07	3.44	4.82	1.36	3.26	0.52	1.97	0.15	0.91	0.02	0.54	0.01	0.34	0.00	0.25	0.00
85					11.72	11.38	7.51	3.85	5.13	1.52	3.46	0.58	2.09	0.17	0.97	0.03	0.57	0.01	0.37	0.00	0.26	0.00
90							7.95	4.28	5.43	1.69	3.66	0.65	2.21	0.19	1.02	0.03	0.60	0.01	0.39	0.00	0.28	0.00
100							8.83	5.20	6.03	2.06	4.07	0.79	2.46	0.23	1.14	0.04	0.67	0.01	0.43	0.00	0.31	0.00
110							9.72	6.21	6.63	2.45	4.48	0.94	2.71	0.28	1.25	0.04	0.74	0.01	0.47	0.00	0.34	0.00
120							10.60	7.30	7.24	2.88	4.88	1.11	2.95	0.33	1.36	0.05	0.80	0.01	0.52	0.00	0.37	0.00
130									7.84	3.34	5.29	1.28	3.20	0.38	1.48	0.06	0.87	0.02	0.56	0.01	0.40	0.00
140									8.44	3.83	5.70	1.47	3.44	0.43	1.59	0.07	0.94	0.02	0.60	0.01	0.43	0.00
150									9.05	4.36	6.11	1.67	3.69	0.49	1.70	0.08	1.00	0.02	0.65	0.01	0.46	0.00
160									9.65	4.91	6.51	1.89	3.94	0.55	1.82	0.08	1.07	0.02	0.69	0.01	0.49	0.00
170									10.25	5.49	6.92	2.11	4.18	0.62	1.93	0.09	1.14	0.03	0.73	0.01	0.52	0.00
180											7.33	2.35	4.43	0.69	2.04	0.11	1.21	0.03	0.78	0.01	0.55	0.00
190											7.73	2.59	4.68	0.76	2.16	0.12	1.27	0.03	0.82	0.01	0.58	0.00
200											8.14	2.85	4.92	0.84	2.27	0.13	1.34	0.04	0.86	0.01	0.61	0.01
225											9.16	3.55	5.54	1.04	2.56	0.16	1.51	0.04	0.97	0.02	0.69	0.01
250											10.18	4.31	6.15	1.27	2.84	0.19	1.67	0.05	1.08	0.02	0.77	0.01
275													6.77	1.51	3.12	0.23	1.84	0.06	1.19	0.02	0.84	0.01
300													7.38	1.78	3.41	0.27	2.01	0.07	1.29	0.03	0.92	0.01

■ Use caution at shaded velocities.

Continued on next page →

← Continued from previous page

SDR 21 (Class 200) PVC Pipe

VELOCITY IN FEET PER SECOND — FRICTION LOSS IN PSI PER 100 FEET (C = 150)																						
Nominal Size (ID) Flow (gpm)	1" (1.189)		1¼" (1.502)		1½" (1.720)		2" (2.149)		2½" (2.601)		3" (3.166)		4" (4.072)		6" (5.993)		8" (7.805)		10" (9.728)		12" (11.538)	
	Vel	Loss	Vel	Loss	Vel	Loss	Vel	Loss	Vel	Loss	Vel	Loss	Vel	Loss	Vel	Loss	Vel	Loss	Vel	Loss	Vel	Loss
325													8.00	2.06	3.69	0.31	2.18	0.09	1.40	0.03	1.00	0.01
350													8.61	2.36	3.98	0.36	2.34	0.10	1.51	0.03	1.07	0.01
375													9.23	2.68	4.26	0.41	2.51	0.11	1.62	0.04	1.15	0.02
400													9.84	3.03	4.54	0.46	2.68	0.13	1.72	0.04	1.23	0.02
425													10.46	3.38	4.83	0.52	2.85	0.14	1.83	0.05	1.30	0.02
450															5.11	0.57	3.01	0.16	1.94	0.05	1.38	0.02
475															5.40	0.63	3.18	0.18	2.05	0.06	1.46	0.03
500															5.68	0.70	3.35	0.19	2.16	0.07	1.53	0.03
550															6.25	0.83	3.68	0.23	2.37	0.08	1.69	0.03
600															6.82	0.98	4.02	0.27	2.59	0.09	1.84	0.04
650															7.38	1.13	4.35	0.31	2.80	0.11	1.99	0.05
700															7.95	1.30	4.69	0.36	3.02	0.12	2.15	0.05
750															8.52	1.48	5.02	0.41	3.23	0.14	2.30	0.06
800															9.09	1.67	5.36	0.46	3.45	0.16	2.45	0.07
850															9.66	1.86	5.69	0.52	3.66	0.18	2.61	0.08
900															10.22	2.07	6.03	0.57	3.88	0.20	2.76	0.09
950																	6.36	0.63	4.10	0.22	2.91	0.09
1000																	6.70	0.70	4.31	0.24	3.06	0.10
1050																	7.03	0.76	4.53	0.26	3.22	0.11
1100																	7.37	0.83	4.74	0.28	3.37	0.12
1150																	7.70	0.90	4.96	0.31	3.52	0.13
1200																	8.04	0.98	5.17	0.33	3.68	0.15
1250																	8.37	1.05	5.39	0.36	3.83	0.16
1300																	8.71	1.13	5.60	0.39	3.98	0.17
1350																	9.04	1.21	5.82	0.42	4.14	0.18
1400																	9.38	1.30	6.04	0.44	4.29	0.19
1450																	9.71	1.39	6.25	0.47	4.44	0.21
1500																	10.05	1.48	6.47	0.51	4.60	0.22
1550																			6.68	0.54	4.75	0.23
1600																			6.90	0.57	4.90	0.25
1650																			7.11	0.60	5.06	0.26
1700																			7.33	0.64	5.21	0.28
1750																			7.54	0.67	5.36	0.29
1800																			7.76	0.71	5.52	0.31
1900																			8.19	0.78	5.82	0.34
2000																			8.62	0.86	6.13	0.38
2100																			9.05	0.94	6.44	0.41
2200																			9.48	1.03	6.74	0.45
2300																			9.92	1.11	7.05	0.49
2400																			10.35	1.21	7.36	0.53
2500																			10.78	1.30	7.66	0.57

■ Use caution at shaded velocities.

Integrated Control System™ Wire Path Design

Recommended to load balance wire path.

Do not utilize the full system capacity of 750 ICMs on one wire path. Instead, leave room to expand the system and add sensing capability in the future.

The wire distance is the “trunk length” of the wire path.

The trunk length is the “longest single run of wire” needed for accommodating the installed ICMs.

Branches can be added to the trunk wire.

Branches do not increase the maximum number of ICMs on the wire path.

Wire Distance in Feet (ft)

No. of Units	1,000	2,000	3,000	4,000	5,000	6,000	7,000	8,000	9,000	10,000	11,000	12,000	13,000	14,000	15,000
50	14 AWG	14 AWG	14 AWG	14 AWG	14 AWG	14 AWG	14 AWG	14 AWG	14 AWG	14 AWG	14 AWG	14 AWG	14 AWG	14 AWG	14 AWG
100	14 AWG	14 AWG	14 AWG	14 AWG	14 AWG	14 AWG	14 AWG	14 AWG	14 AWG	14 AWG	14 AWG	14 AWG	14 AWG	14 AWG	14 AWG
150	14 AWG	14 AWG	14 AWG	14 AWG	14 AWG	14 AWG	14 AWG	14 AWG	14 AWG	14 AWG	14 AWG	14 AWG	14 AWG	14 AWG	14 AWG
200	14 AWG	14 AWG	14 AWG	14 AWG	14 AWG	14 AWG	14 AWG	14 AWG	14 AWG	14 AWG	14 AWG	14 AWG	14 AWG	14 AWG	14 AWG
250	14 AWG	14 AWG	14 AWG	14 AWG	14 AWG	14 AWG	14 AWG	14 AWG	14 AWG	14 AWG	14 AWG	14 AWG	14 AWG	14 AWG	12 AWG
300	14 AWG	14 AWG	14 AWG	14 AWG	14 AWG	14 AWG	14 AWG	14 AWG	14 AWG	14 AWG	14 AWG	12 AWG	12 AWG	12 AWG	12 AWG
350	14 AWG	14 AWG	14 AWG	14 AWG	14 AWG	14 AWG	14 AWG	14 AWG	14 AWG	14 AWG	12 AWG	12 AWG	12 AWG	12 AWG	12 AWG
400	14 AWG	14 AWG	14 AWG	14 AWG	14 AWG	14 AWG	14 AWG	14 AWG	12 AWG	12 AWG	12 AWG	12 AWG	12 AWG	12 AWG	12 AWG
450	14 AWG	14 AWG	14 AWG	14 AWG	14 AWG	14 AWG	14 AWG	12 AWG	12 AWG	12 AWG	12 AWG	12 AWG	12 AWG	12 AWG	12 AWG
500	14 AWG	14 AWG	14 AWG	14 AWG	14 AWG	14 AWG	14 AWG	12 AWG	12 AWG	12 AWG	12 AWG	12 AWG	12 AWG	12 AWG	10 AWG
550	14 AWG	14 AWG	14 AWG	14 AWG	14 AWG	14 AWG	12 AWG	12 AWG	12 AWG	12 AWG	12 AWG	12 AWG	10 AWG	10 AWG	10 AWG
600	14 AWG	14 AWG	14 AWG	14 AWG	14 AWG	12 AWG	12 AWG	12 AWG	12 AWG	12 AWG	12 AWG	10 AWG	10 AWG	10 AWG	10 AWG
650	14 AWG	14 AWG	14 AWG	14 AWG	14 AWG	12 AWG	12 AWG	12 AWG	12 AWG	12 AWG	10 AWG	10 AWG	10 AWG	—	—
700	14 AWG	14 AWG	14 AWG	14 AWG	14 AWG	12 AWG	12 AWG	12 AWG	12 AWG	10 AWG	10 AWG	10 AWG	—	—	—
750	14 AWG	14 AWG	14 AWG	14 AWG	12 AWG	12 AWG	12 AWG	12 AWG	10 AWG	10 AWG	10 AWG	10 AWG	—	—	—

Wire Distance in Meters (m)

No. of Units	1,000	1,250	1,500	1,750	2,000	2,250	2,500	2,750	3,000	3,250	3,500	3,750	4,000	4,250	4,500
50	2.5 mm ²	2.5 mm ²	2.5 mm ²	2.5 mm ²	2.5 mm ²	2.5 mm ²	2.5 mm ²	2.5 mm ²	2.5 mm ²	2.5 mm ²	2.5 mm ²	2.5 mm ²	2.5 mm ²	2.5 mm ²	2.5 mm ²
100	2.5 mm ²	2.5 mm ²	2.5 mm ²	2.5 mm ²	2.5 mm ²	2.5 mm ²	2.5 mm ²	2.5 mm ²	2.5 mm ²	2.5 mm ²	2.5 mm ²	2.5 mm ²	2.5 mm ²	2.5 mm ²	2.5 mm ²
150	2.5 mm ²	2.5 mm ²	2.5 mm ²	2.5 mm ²	2.5 mm ²	2.5 mm ²	2.5 mm ²	2.5 mm ²	2.5 mm ²	2.5 mm ²	2.5 mm ²	2.5 mm ²	2.5 mm ²	2.5 mm ²	2.5 mm ²
200	2.5 mm ²	2.5 mm ²	2.5 mm ²	2.5 mm ²	2.5 mm ²	2.5 mm ²	2.5 mm ²	2.5 mm ²	2.5 mm ²	2.5 mm ²	2.5 mm ²	2.5 mm ²	2.5 mm ²	2.5 mm ²	2.5 mm ²
250	2.5 mm ²	2.5 mm ²	2.5 mm ²	2.5 mm ²	2.5 mm ²	2.5 mm ²	2.5 mm ²	2.5 mm ²	2.5 mm ²	2.5 mm ²	2.5 mm ²	2.5 mm ²	2.5 mm ²	2.5 mm ²	2.5 mm ²
300	2.5 mm ²	2.5 mm ²	2.5 mm ²	2.5 mm ²	2.5 mm ²	2.5 mm ²	2.5 mm ²	2.5 mm ²	2.5 mm ²	2.5 mm ²	2.5 mm ²	2.5 mm ²	2.5 mm ²	4.0 mm ²	4.0 mm ²
350	2.5 mm ²	2.5 mm ²	2.5 mm ²	2.5 mm ²	2.5 mm ²	2.5 mm ²	2.5 mm ²	2.5 mm ²	2.5 mm ²	2.5 mm ²	2.5 mm ²	4.0 mm ²	4.0 mm ²	4.0 mm ²	4.0 mm ²
400	2.5 mm ²	2.5 mm ²	2.5 mm ²	2.5 mm ²	2.5 mm ²	2.5 mm ²	2.5 mm ²	2.5 mm ²	2.5 mm ²	4.0 mm ²	4.0 mm ²	4.0 mm ²	4.0 mm ²	4.0 mm ²	4.0 mm ²
450	2.5 mm ²	2.5 mm ²	2.5 mm ²	2.5 mm ²	2.5 mm ²	2.5 mm ²	2.5 mm ²	2.5 mm ²	4.0 mm ²	4.0 mm ²	4.0 mm ²	4.0 mm ²	4.0 mm ²	4.0 mm ²	4.0 mm ²
500	2.5 mm ²	2.5 mm ²	2.5 mm ²	2.5 mm ²	2.5 mm ²	2.5 mm ²	4.0 mm ²	4.0 mm ²	4.0 mm ²	4.0 mm ²	4.0 mm ²	4.0 mm ²	4.0 mm ²	4.0 mm ²	4.0 mm ²
550	2.5 mm ²	2.5 mm ²	2.5 mm ²	2.5 mm ²	2.5 mm ²	2.5 mm ²	4.0 mm ²	4.0 mm ²	4.0 mm ²	4.0 mm ²	4.0 mm ²	4.0 mm ²	4.0 mm ²	4.0 mm ²	6.0 mm ²
600	2.5 mm ²	2.5 mm ²	2.5 mm ²	2.5 mm ²	2.5 mm ²	4.0 mm ²	4.0 mm ²	4.0 mm ²	4.0 mm ²	4.0 mm ²	4.0 mm ²	4.0 mm ²	4.0 mm ²	6.0 mm ²	6.0 mm ²
650	2.5 mm ²	2.5 mm ²	2.5 mm ²	2.5 mm ²	4.0 mm ²	4.0 mm ²	4.0 mm ²	4.0 mm ²	4.0 mm ²	4.0 mm ²	4.0 mm ²	6.0 mm ²	6.0 mm ²	6.0 mm ²	6.0 mm ²
700	2.5 mm ²	2.5 mm ²	2.5 mm ²	2.5 mm ²	4.0 mm ²	4.0 mm ²	4.0 mm ²	4.0 mm ²	4.0 mm ²	4.0 mm ²	6.0 mm ²	6.0 mm ²	6.0 mm ²	6.0 mm ²	—
750	2.5 mm ²	2.5 mm ²	2.5 mm ²	2.5 mm ²	4.0 mm ²	4.0 mm ²	4.0 mm ²	4.0 mm ²	4.0 mm ²	6.0 mm ²	6.0 mm ²	6.0 mm ²	6.0 mm ²	—	—

Water Velocity

Flow gpm	Internal Pipe Diameter																							
	2"	4"	6"	8"	10"	12"	14"	16"	18"	20"	22"	24"	26"	28"	30"	32"	34"	36"	38"	40"	42"	44"	46"	48"
10	1.0	0.3	0.1	0.1	—	—	—	—	—	—	—	—	—	—	—	—	—	—	—	—	—	—	—	—
20	2.0	0.5	0.2	0.1	0.1	0.1	—	—	—	—	—	—	—	—	—	—	—	—	—	—	—	—	—	—
30	3.1	0.8	0.3	0.2	0.1	0.1	0.1	—	—	—	—	—	—	—	—	—	—	—	—	—	—	—	—	—
40	4.1	1.0	0.5	0.3	0.2	0.1	0.1	0.1	0.1	—	—	—	—	—	—	—	—	—	—	—	—	—	—	—
50	5.1	1.3	0.6	0.3	0.2	0.1	0.1	0.1	0.1	0.1	—	—	—	—	—	—	—	—	—	—	—	—	—	—
60	6.1	1.5	0.7	0.4	0.2	0.2	0.1	0.1	0.1	0.1	0.1	—	—	—	—	—	—	—	—	—	—	—	—	—
70	7.2	1.8	0.8	0.4	0.3	0.2	0.1	0.1	0.1	0.1	0.1	—	—	—	—	—	—	—	—	—	—	—	—	—
80	8.2	2.0	0.9	0.5	0.3	0.2	0.2	0.1	0.1	0.1	0.1	0.1	—	—	—	—	—	—	—	—	—	—	—	—
90	9.2	2.3	1.0	0.6	0.4	0.3	0.2	0.1	0.1	0.1	0.1	0.1	0.1	—	—	—	—	—	—	—	—	—	—	—
100	10.2	2.6	1.1	0.6	0.4	0.3	0.2	0.2	0.1	0.1	0.1	0.1	0.1	0.1	—	—	—	—	—	—	—	—	—	—
150	15.3	3.8	1.7	1.0	0.6	0.4	0.3	0.2	0.2	0.2	0.1	0.1	0.1	0.1	0.1	0.1	—	—	—	—	—	—	—	—
200	20.4	5.1	2.3	1.3	0.8	0.6	0.4	0.3	0.3	0.2	0.2	0.1	0.1	0.1	0.1	0.1	0.1	0.1	0.1	0.1	—	—	—	—
250	25.5	6.4	2.8	1.6	1.0	0.7	0.5	0.4	0.3	0.3	0.2	0.2	0.2	0.1	0.1	0.1	0.1	0.1	0.1	0.1	0.1	0.1	—	—
300	30.7	7.7	3.4	1.9	1.2	0.9	0.6	0.5	0.4	0.3	0.3	0.2	0.2	0.2	0.1	0.1	0.1	0.1	0.1	0.1	0.1	0.1	0.1	0.1
350	35.8	8.9	4.0	2.2	1.4	1.0	0.7	0.6	0.4	0.4	0.3	0.2	0.2	0.2	0.2	0.1	0.1	0.1	0.1	0.1	0.1	0.1	0.1	0.1
400	40.9	10.2	4.5	2.6	1.6	1.1	0.8	0.6	0.5	0.4	0.3	0.3	0.2	0.2	0.2	0.2	0.1	0.1	0.1	0.1	0.1	0.1	0.1	0.1
450	46.0	11.5	5.1	2.9	1.8	1.3	0.9	0.7	0.6	0.5	0.4	0.3	0.3	0.2	0.2	0.2	0.2	0.1	0.1	0.1	0.1	0.1	0.1	0.1
500	51.1	12.8	5.7	3.2	2.0	1.4	1.0	0.8	0.6	0.5	0.4	0.4	0.3	0.3	0.2	0.2	0.2	0.2	0.1	0.1	0.1	0.1	0.1	0.1
600	61.3	15.3	6.8	3.8	2.5	1.7	1.3	1.0	0.8	0.6	0.5	0.4	0.4	0.3	0.3	0.2	0.2	0.2	0.2	0.2	0.1	0.1	0.1	0.1
700	71.5	17.9	7.9	4.5	2.9	2.0	1.5	1.1	0.9	0.7	0.6	0.5	0.4	0.4	0.3	0.3	0.2	0.2	0.2	0.2	0.2	0.1	0.1	0.1
800	81.7	20.4	9.1	5.1	3.3	2.3	1.7	1.3	1.0	0.8	0.7	0.6	0.5	0.4	0.4	0.3	0.3	0.3	0.2	0.2	0.2	0.2	0.2	0.1
900	92.0	23.0	10.2	5.7	3.7	2.6	1.9	1.4	1.1	0.9	0.8	0.6	0.5	0.5	0.4	0.4	0.3	0.3	0.3	0.2	0.2	0.2	0.2	0.2
1000	102.2	25.5	11.4	6.4	4.1	2.8	2.1	1.6	1.3	1.0	0.8	0.7	0.6	0.5	0.5	0.4	0.4	0.3	0.3	0.3	0.2	0.2	0.2	0.2
1250	127.7	31.9	14.2	8.0	5.1	3.5	2.6	2.0	1.6	1.3	1.1	0.9	0.8	0.7	0.6	0.5	0.4	0.4	0.4	0.3	0.3	0.3	0.2	0.2
1500	153.3	38.3	17.0	9.6	6.1	4.3	3.1	2.4	1.9	1.5	1.3	1.1	0.9	0.8	0.7	0.6	0.5	0.5	0.4	0.4	0.3	0.3	0.3	0.3
1750	178.8	44.7	19.9	11.2	7.2	5.0	3.6	2.8	2.2	1.8	1.5	1.2	1.1	0.9	0.8	0.7	0.6	0.6	0.5	0.4	0.4	0.4	0.3	0.3
2000	204.4	51.1	22.7	12.8	8.2	5.7	4.2	3.2	2.5	2.0	1.7	1.4	1.2	1.0	0.9	0.8	0.7	0.6	0.6	0.5	0.5	0.4	0.4	0.4
2500	255.4	63.9	28.4	16.0	10.2	7.1	5.2	4.0	3.2	2.6	2.1	1.8	1.5	1.3	1.1	1.0	0.9	0.8	0.7	0.6	0.6	0.5	0.5	0.4
3000	306.5	76.6	34.1	19.2	12.3	8.5	6.3	4.8	3.8	3.1	2.5	2.1	1.8	1.6	1.4	1.2	1.1	0.9	0.8	0.8	0.7	0.6	0.6	0.5
3500	357.6	89.4	39.7	22.4	14.3	9.9	7.3	5.6	4.4	3.6	3.0	2.5	2.1	1.8	1.6	1.4	1.2	1.1	1.0	0.9	0.8	0.7	0.7	0.6
4000	408.7	102.2	45.4	25.5	16.3	11.4	8.3	6.4	5.0	4.1	3.4	2.8	2.4	2.1	1.8	1.6	1.4	1.3	1.1	1.0	0.9	0.8	0.8	0.7
4500	459.8	114.9	51.1	28.7	18.4	12.8	9.4	7.2	5.7	4.6	3.8	3.2	2.7	2.3	2.0	1.8	1.6	1.4	1.3	1.1	1.0	0.9	0.9	0.8
5000	510.9	127.7	56.8	31.9	20.4	14.2	10.4	8.0	6.3	5.1	4.2	3.5	3.0	2.6	2.3	2.0	1.8	1.6	1.4	1.3	1.2	1.1	1.0	0.9
5500	562.0	140.5	62.4	35.1	22.5	15.6	11.5	8.8	6.9	5.6	4.6	3.9	3.3	2.9	2.5	2.2	1.9	1.7	1.6	1.4	1.3	1.2	1.1	1.0
6000	613.1	153.3	68.1	38.3	24.5	17.0	12.5	9.6	7.6	6.1	5.1	4.3	3.6	3.1	2.7	2.4	2.1	1.9	1.7	1.5	1.4	1.3	1.2	1.1

Main line pipe diameter under standard practice is sized to achieve < 5 feet-per-second water velocity. Wet-well intake pipe diameter under standard practice is sized to achieve < 1.5 feet-per-second water velocity. Velocities listed are based on the actual internal diameter for the pipe. Verify internal diameter based on class or type of pipe being used.

Controller Power Wiring Sizing Worksheet

	PAR+ES	PAR+ES Link with Radio	PAR+ES SAT Decoder**	PAR+ES SAT Decoder Link with Radio**
Input (VAC)	117	117	117	117
Output (VAC)	26.5	26.5	26.5	26.5
Simultaneous Rain Bird Solenoids at 60 Hz (50 Hz) per Controller†	16 (12)	16 (12)	16 (12)	16 (12)
Simultaneous Rain Bird Solenoids at 60 Hz (50 Hz) per Station	4	4	2	2
AMP Draw at Rest‡	0.15	0.17	0.235	0.250
1	0.22	0.24	0.250	0.265
2	0.30	0.32	0.258	0.273
3	0.37	0.40	0.264	0.281
4	0.45	0.47	0.272	0.289
5	0.52	0.54	0.280	0.297
6	0.60	0.62	0.288	0.305
7	0.67	0.70	0.296	0.313
8	0.75	0.77	0.304	0.321
9	0.82	0.84	0.312	0.329
10	0.90	0.92	0.320	0.337
11	0.97	0.99	0.328	0.345
12	1.05	1.07	0.336	0.353
13	1.12	1.14	0.344	0.361
14	1.20	1.22	0.352	0.369
15	1.27	1.29	0.360	0.377
16	1.35	1.37	0.368	0.385

*Includes Master Valve. **Considering 72 decoders installed. † Total AMP Draw in chart is based on 117 VAC input. For 220/240 VAC input controllers, use 50% of amp draw shown in chart.

Rain Bird will repair or replace at no charge any Rain Bird professional product that fails in normal use within the warranty period stated below. You must return it to the dealer or distributor where you bought it. Product failures due to acts of God including without limitation, lightning and flooding, are not covered by this warranty. This commitment to repair or replace is our sole and total warranty.

Implied Warranties of Merchantability and Fitness, if Applicable, are Limited to One Year from the Date of Sale. We will not, under any circumstances be liable for incidental or consequential damages, no matter how they occur.

I. Landscape Irrigation Products

1800® Series Pop-Up Spray Heads, U-Series Nozzles, Brass MPR Nozzles, A-8S and PA-8S-PRS Shrub Adapters, and 1300 and 1400 Bubblers, 5000 Series Rotors, 5500 Series Rotors, 7005/8005 Rotors, Falcon® 6504 Series Rotors, PEB and PESB Plastic Valves – **5 Years**

All other Landscape Irrigation products – **3 years**

II. Golf Products

Rain Bird Golf Rotors – **3 years**, extended to **5 years** if installed in conjunction with Rain Bird Swing Joints. Proof of concurrent installation is required.

Swing Joints – **5 years**

Brass Remote Control Valves, Valve Boxes and Brass Quick Coupling and Keys – **3 years**

Filtration system controllers – **3 years**

LINK™ Radios – **3 years**

Golf Controllers and Satellites – **1 year**

All other golf products – **1 year**

III. Agricultural Products

LF Series Sprinklers – **5 years**

Other Impact Sprinklers – **2 years**

All other AG products – **1 year**

IV. Pump Stations

Rain Bird guarantees that its pump station will be free of manufacturer defects for three years from the date of start-up but not beyond forty months from the date of purchase by the original customer with a copy of the seller's invoice required for coverage under this Policy. Start-up or service by anyone other than a Rain Bird authorized representative, when required, will void these terms and conditions.

Provided that all installation, start-up, operation responsibilities, and recommended maintenance procedures have been properly executed and performed by authorized Rain Bird representatives, when required, Rain Bird will replace or repair, at Rain Bird's option, any Rain Bird part found to be defective under normal recommended use during the effective period of this Policy, such evaluation to be solely determined by Rain Bird. Rain Bird's only obligation and customer's exclusive remedy under this Policy is limited to repair or replacement, at Rain Bird's option, of the parts or the products the defects of which are reported to Rain Bird within the applicable Policy period, which prove to be defective and such evaluation will be solely determined by Rain Bird.

In no case will Rain Bird cover labor costs associated with repair or replacement of parts beyond one year from date of start-up. Repairs performed and parts used at Rain Bird's expense must be authorized by Rain Bird, in writing, prior to repairs being performed. Product repairs or replacement under this Policy will not extend this Policy. Coverage for repaired or replaced product shall end when this Policy terminates. Rain Bird's sole obligation and customer's exclusive remedy under this Policy shall be limited to such repair or replacement.

Upon request, Rain Bird may provide advice on trouble-shooting a defect during the effective period of this Customer Satisfaction Policy. Repair service must be performed by a Rain Bird authorized representative regardless of whether the labor is covered by Rain Bird or is at the owner's expense during the effective period of this Policy. However, no service, replacement or repair under this Customer Satisfaction Policy will be rendered while the customer is in default of any payments due to Rain Bird.

Rain Bird will not accept responsibility for costs associated with the removal, replacement or repair of equipment in difficult-to-access locations and such evaluation will be solely determined by

Rain Bird. Difficult-to-access locations include (but are not limited to) locations where any of the following are required:

- | | |
|-------------------------------|--|
| 1) Cranes larger than 15 tons | 5) Dredging |
| 2) Divers | 6) Roof removal or other such construction/deconstruction requirements |
| 3) Barges | 7) Any other unusual means or requirements |
| 4) Helicopters | |

Such extraordinary cost associated with difficult-to-access locations shall be the sole responsibility of the customer, regardless of the reason requiring removal, repair or replacement of the equipment.

The terms and conditions of this Customer Satisfaction Policy do not cover damage, loss or injury caused by or resulting from the following:

- | | |
|---|---|
| 1) Misapplication, abuse, or failure to conduct routine maintenance (to include winterization/winter lay-up procedures). | 9) Non-WYE configured power supplies such as open delta, phase converters or other forms of unbalanced three phase power supplies. |
| 2) Pumping of liquids other than fresh water as defined by the U.S. Environmental Protection Agency, unless the pump station quoted by Rain Bird specifically lists these other liquids and their concentrations. | 10) Improper electrical grounding or exposure to incoming power lacking circuit breaker or fused protection. |
| 3) Use of pesticides (to include insecticides, fungicides and herbicides), free chlorine or other strong biocides. | 11) Using the control panel as a service disconnect. |
| 4) Exposure to electrolysis, erosion, or abrasion. | 12) Lightning, earthquake, flood, windstorm or other Acts of Nature. |
| 5) Use or presence of destructive gases or chemicals unless these materials and their concentrations are specified in the Rain Bird quotation. | 13) Failure of pump packing seal (unless the failure occurs on initial start-up). |
| 6) Electrical supply voltages above or below those specified for correct pump station operation. | 14) Any damage or loss to plants, equipment or groundwater or injury to people caused by the failure of or improper use of an injection system or improper concentration of chemicals or plant nutrients introduced into the pump station by an injection system. |
| 7) Electrical phase loss or reversal. | 15) Any failure of nutrient or chemical storage or spill containment equipment or facilities associated with the pump station location. |
| 8) Use of a power source other than that specified in the original quotation. | |

The foregoing terms and conditions constitute Rain Bird's entire pump station customer satisfaction policy. This policy is exclusive and in lieu of any other warranties whatsoever, whether express, implied, or statutory including the implied warranties of merchantability and fitness for a particular purpose, which are all hereby expressly disclaimed. The sole remedy under this policy shall be limited to the repair or replacement of the pump station or its components pursuant to the terms and conditions contained herein. In the case of any components or injection systems manufactured by others (as noted on the pump station quotation), there is no warranty provided by Rain Bird and these items are covered solely by and to the extent of the warranty if any, offered by those other manufacturers.

Rain Bird shall not be liable to the customer or any other person or entity for any liability, loss, delay or damage caused or alleged to be caused, directly or indirectly, by any use, defect, failure or malfunction of the pump station or by any injection system whether a claim for such liability, loss, delay or damages is based upon warranty, contract, tort or otherwise. Rain Bird shall not be liable for incidental, consequential, collateral or indirect damages or delay or loss of profit or loss of use or any damages related to the customer's business operations, nor for those caused by acts of nature. In no case and under no circumstances shall Rain Bird's liability exceed the Rain Bird Corporation's net sale price of the pump station.

Laws concerning customer warranties and disclaimers vary from state to state, jurisdiction to jurisdiction, province to province or country to country and therefore some of the foregoing limitations may not apply to you. The exclusions and limitations set out above are not intended to, and should not be construed so as to contravene mandatory provisions of applicable law. If any part or term of this policy is held to be illegal, unenforceable or in conflict with applicable law by a court of competent jurisdiction, the validity of the remaining portions of this policy shall not be affected, and all rights and obligations shall be construed and enforced as if this policy did not contain the particular part or term held to be invalid.

V. All other products – 1 year

1.5" Inline Commercial Control Zone Kit	89	IC Module	27	Selector Service Tool / Key	23
18" Selector Valve Key	23	IC Rotors	26	Self-Cleaning Pump Suction Screen	48
1800® Series Spray Heads	63	IC System™	24	Service Tools	23
5000 Series MPR Nozzles	76	IC Valves	26	Smart Pump™	47
5000 Series Rotors	74	IC-IN	28	Snap-Ring Pliers	23
552 Block Rotors	20	IC-OUT	29	Sod Cup Kit	23
7" Selector Valve Key	23	IFX Satellite Board	41	StratusLT™	8
702 Series Rotors	18	Integrated Control Interface Plus (ICI+)	40	Stratus™ II	8
752 Rear-Spreader Nozzles	16	Integrated Course Control	38	Swing Joints	22
752 Series Rotors	14	Landscape Solutions	60	TBOS Battery-Operated Controller	93
952 Rear-Spreader Nozzles	13	Large-Capacity Filters	90	The FREEDOM System™	9
952 Series Rotors	12	Nimbus™ II	8	Top-Serviceable Rock Screen Installation Socket	23
Automatic Backwashing Wedge-Wire Screen Filter	48	PAR+ES Controller	32	Twist Lock Fittings	84
Central Control Technologies	4	PAR+ES Sat Decoder Controller	34	U-Series Nozzles	72
Centrifugal Sand Separators	48	PESIC Series	56	UF Cable Stripper	23
CirrusPRO™	6	PRS-DIAL	56	Universal Hose Adapter	23
Decoders	35	Pump Manager 2	47	Valve Boxes	58
E-Series Electric Suction Scanning Filter	50	Pump Station Quick Reference Guide	44	Valve Insertion Tool	23
Easy Fit Compression System	84	Pump Stations & Filtration	42	Valves	52
ESP-9V Battery-Operated Controller	92	QF Dripline Header	82	WC100 Wire Connectors	37
Field Control	30	Quick Coupling Valves	59	Weather Station	8
G-Series Hydraulic Suction Scanning Filter	51	R-VAN Rotary Nozzles	64	Xeri-Bubblers™	88
Golf Rotors	10	R-VAN Rotary Strip Nozzles	68	Xeri-Bug™ Emitters	88
Golf Rotors Comparison Chart	21	R-VAN14 Rotary Nozzles	65	Xeri-Bug™ with Check Valve	86
GSV / GSVIC Series Valves	54	R-VAN18 Rotary Nozzles	66	XF Dripline Insert Fittings	84
HDF 2 Disc Filters	48	R-VAN24 Rotary Nozzles	67	XF Series Blank Tubing	85
HE-VAN Series Nozzles	69	Rain Can	8	XFD On-Surface Dripline	83
I-Series Hydraulic Suction Scanning Filter	49	RD1800™ Series Spray Heads	62	XFS-CV Series Dripline	80
IC CONNECT™	28	Root Watering System (RWS)	78	XT-700 Distribution Tubing	85
		Rotor Tool	23		

The Intelligent Use of Water.™

LEADERSHIP • EDUCATION • PARTNERSHIPS • PRODUCTS

At Rain Bird, we believe it is our responsibility to develop products and technologies that use water efficiently. Our commitment also extends to education, training and services for our industry and our communities.

The need to conserve water has never been greater. We want to do even more, and with your help, we can. Visit www.rainbird.com for more information about The Intelligent Use of Water.™



Distributed by:



www.centaur-asiapacific.com
info@centaur-asiapacific.com

*Singapore for Golf courses only.